

FPF2165R Full Function Load Switch with Adjustable Current Limit

Features

- 1.8 to 5.5V Input Voltage Range
- Controlled Turn-On
- 0.15-1.5A Adjustable Current Limit
- +/- 10% Current Limit Accuracy versus Temperature
- Undervoltage Lockout
- Thermal Shutdown
- <2µA Shutdown Current
- Fast Current limit Response Time
 - 5µs to Moderate Over Currents
 - 30ns to Hard Shorts
- Reverse Current Blocking
- RoHS Compliant

Applications

- PDAs
- Cell Phones
- GPS Devices
- MP3 Players
- Digital Cameras
- Peripheral Ports
- Hot Swap Supplies



General Description

The FPF2165R is a load switch which provides full protection to systems and loads which may encounter large current conditions. These devices contain a 0.12Ω current-limited P-channel MOSFET which can operate over an input voltage range of 1.8-5.5V. Internally, current is prevented from flowing when the MOSFET is off and the output voltage is higher than the input voltage. Switch control is by a logic input (ON) capable of interfacing directly with low voltage control signals. Each part contains thermal shutdown protection which shuts off the switch to prevent damage to the part when a continuous over-current condition causes excessive heating.

When the switch current reaches the current limit, the parts operate in a constant-current mode to prohibit excessive currents from causing damage. The FPF2165R will not turn off after a current limit fault, but will rather remain in the constant current mode indefinitely. The minimum current limit is 150mA.

These parts are available in a space-saving 6 pin 2X2 MLP package.

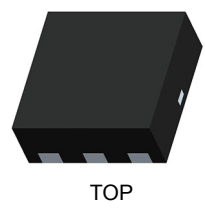
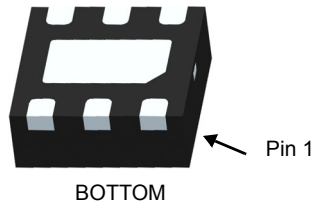

Ordering Information

| Part | Current Limit [mA] | Current Limit Blanking Time [ms] | Auto-Restart Time [ms] | ON Pin Activity | Top Mark |
|----------|--------------------|----------------------------------|------------------------|-----------------|----------|
| FPF2165R | 150-1500 | 0 | NA | Active HI | 65R |

Typical Application Circuit

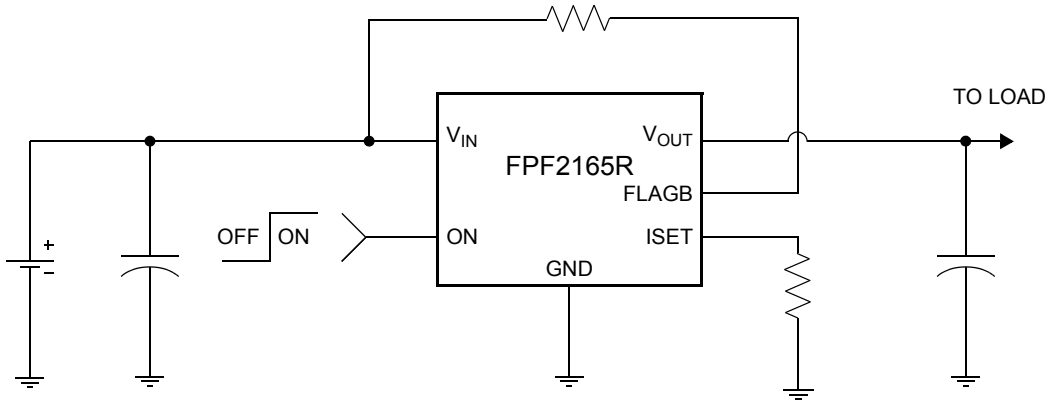

Functional Block Diagram

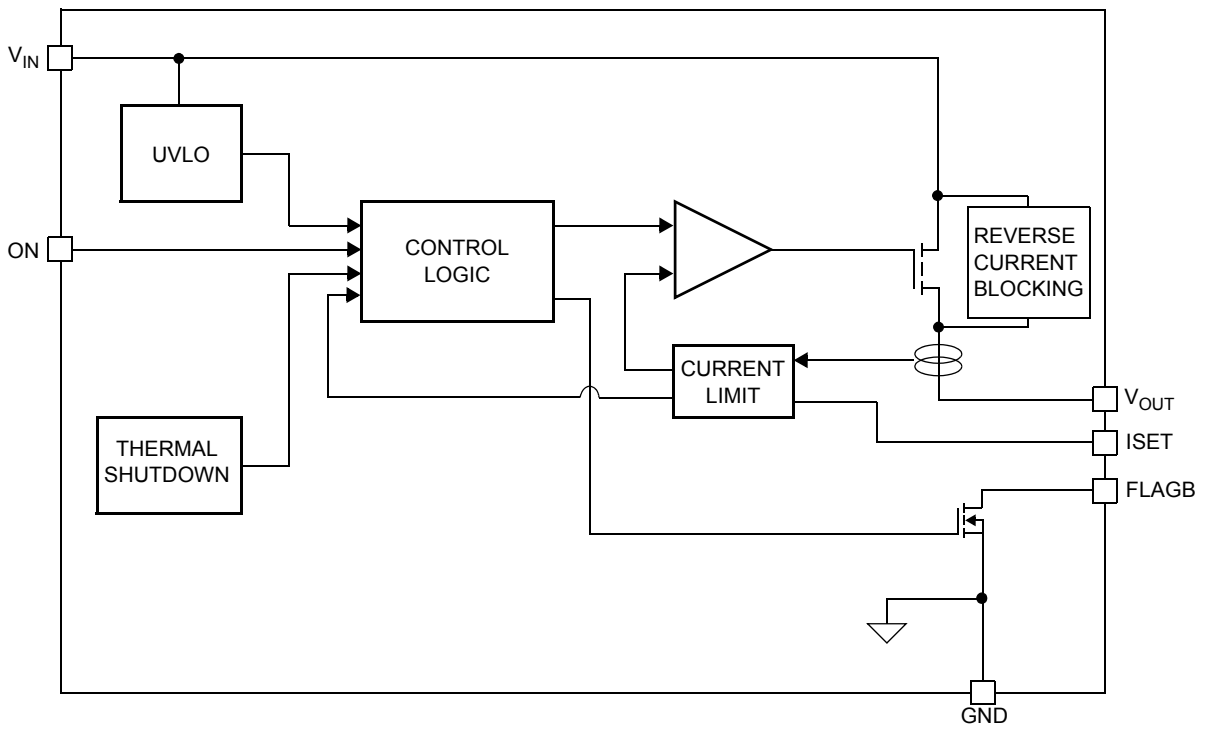

Pin Configuration

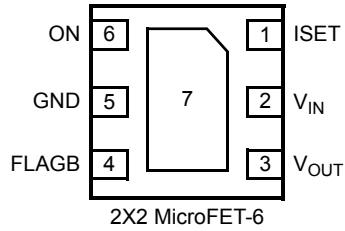

Pin Description

| Pin | Name | Function |
|------|------------------|--|
| 1 | ISET | Current Limit Set Input: A resistor from ISET to ground sets the current limit for the switch. |
| 2 | V _{IN} | Supply Input: Input to the power switch and the supply voltage For the IC |
| 3 | V _{OUT} | Switch Output: Output of the power switch |
| 4 | FLAGB | Fault Output: Active LO, open drain output which indicates an over current supply under voltage or over temperature state. |
| 5, 7 | GND | Ground |
| 6 | ON | ON Control Input |

Absolute Maximum Ratings

| Parameter | Min. | Max. | Unit | |
|---|---------------|-------------------|-------|---|
| V _{IN} , V _{OUT} , ON, FLAGB, ISET to GND | -0.3 | 6 | V | |
| Power Dissipation | | 1.2 | W | |
| Operating and Storage Junction Temperature | -65 | 150 | °C | |
| Thermal Resistance, Junction to Ambient | | 86 | °C/W | |
| Electrostatic Discharge Protection | Jedec A114A | HBM | 4000 | V |
| | Jedec C101C | CDM | 2000 | V |
| | Jedec A115 | MM | 400 | V |
| | IEC 61000-4-2 | Air Discharge | 15000 | V |
| | | Contact Discharge | 8000 | V |

Recommended Operating Range

| Parameter | Min | Max | Unit |
|---|-----|-----|------|
| V _{IN} | 1.8 | 5.5 | V |
| Ambient Operating Temperature, T _A | -40 | 85 | °C |

Electrical Characteristics

V_{IN} = 1.8 to 5.5V, T_A = -40 to +85°C unless otherwise noted. Typical values are at V_{IN} = 3.3V and T_A = 25°C.

| Parameter | Symbol | Conditions | Min | Typ | Max | Units | |
|------------------------|-----------------|------------------------|------------------------|-----|-----|-------|----|
| Basic Operation | | | | | | | |
| Operating Voltage | V _{IN} | | 1.8 | | 5.5 | V | |
| Quiescent Current | I _Q | I _{OUT} = 0mA | V _{IN} = 1.8V | | 63 | 100 | μA |
| | | | V _{IN} = 3.3V | | 68 | | |
| | | | V _{IN} = 5.5V | | 77 | 120 | |

Electrical Characteristics Cont.
 $V_{IN} = 1.8$ to $5.5V$, $T_A = -40$ to $+85^{\circ}C$ unless otherwise noted. Typical values are at $V_{IN} = 3.3V$ and $T_A = 25^{\circ}C$.

| Parameter | Symbol | Conditions | Min | Typ | Max | Units |
|-----------------------------------|------------|--|------|------|------|-------------|
| On-Resistance | R_{ON} | $V_{IN} = 3.3V, I_{OUT} = 200mA, T_A = 25^{\circ}C$ | | 120 | 160 | m Ω |
| | | $V_{IN} = 3.3V, I_{OUT} = 200mA, T_A = 85^{\circ}C$ | | 135 | 180 | |
| | | $V_{IN} = 3.3V, I_{OUT} = 200mA, T_A = -40^{\circ}C$ to $+85^{\circ}C$ | 65 | | 180 | |
| | | $V_{IN} = 5V, I_{OUT} = 200mA, T_A = 25^{\circ}C$ | | 95 | 124 | |
| | | $V_{IN} = 5V, I_{OUT} = 200mA, T_A = 85^{\circ}C$ | | 110 | 143 | |
| | | $V_{IN} = 5V, I_{OUT} = 200mA, T_A = -40^{\circ}C$ to $+85^{\circ}C$ | 58 | | 143 | |
| ON Input Logic High Voltage (ON) | V_{IH} | $V_{IN} = 1.8V$ | 0.8 | | | V |
| | | $V_{IN} = 5.5V$ | 1.4 | | | |
| ON Input Logic Low Voltage | V_{IL} | $V_{IN} = 1.8V$ | | | 0.5 | V |
| | | $V_{IN} = 5.5V$ | | | 1 | |
| ON Input Leakage | | $V_{ON} = V_{IN}$ or GND | -1 | | 1 | μA |
| V_{IN} Shutdown Current | | $V_{ON} = 0V, V_{IN} = 5.5V,$ $V_{OUT} =$ short to GND | -2 | | 2 | μA |
| FLAGB Output Logic Low Voltage | | $V_{IN} = 5V, I_{SINK} = 10mA$ | | 0.05 | 0.2 | V |
| | | $V_{IN} = 1.8V, I_{SINK} = 10mA$ | | 0.12 | 0.3 | |
| FLAGB Output High Leakage Current | | $V_{IN} = 5V$, Switch on | | | 1 | μA |
| Reverse Block | | | | | | |
| V_{OUT} Shutdown Current | | $V_{ON} = 0V, V_{OUT} = 5.5V,$ $V_{IN} =$ short to GND | -2 | | 2 | μA |
| Protections | | | | | | |
| Current Limit | I_{LIM} | $V_{IN} = 3.3V, V_{OUT} = 3.0V, R_{SET} = 1840\Omega$ | 135 | 150 | 165 | mA |
| | | $V_{IN} = 3.3V, V_{OUT} = 3.0V, R_{SET} = 361\Omega$ | 720 | 800 | 880 | mA |
| | | $V_{IN} = 3.3V, V_{OUT} = 3.0V, R_{SET} = 196\Omega$ | 1350 | 1500 | 1650 | mA |
| Thermal Shutdown | | Shutdown Threshold | | 140 | | $^{\circ}C$ |
| | | Return from Shutdown | | 130 | | |
| | | Hysteresis | | 10 | | |
| Under Voltage Shutdown | UVLO | V_{IN} Increasing | 1.55 | 1.65 | 1.75 | V |
| Under Voltage Shutdown Hysteresis | | | | 50 | | mV |
| Dynamic | | | | | | |
| Delay On Time | t_{dON} | $R_L = 500\Omega, C_L = 0.1\mu F$ | | 25 | | μs |
| Delay Off Time | t_{dOFF} | $R_L = 500\Omega, C_L = 0.1\mu F$ | | 45 | | μs |
| V_{OUT} Rise Time | t_{RISE} | $R_L = 500\Omega, C_L = 0.1\mu F$ | | 10 | | μs |
| V_{OUT} Fall Time | t_{FALL} | $R_L = 500\Omega, C_L = 0.1\mu F$ | | 110 | | μs |
| Short Circuit Response Time | | $V_{IN} = V_{OUT} = 3.3V$. Moderate Over-Current Condition. | | 5 | | μs |
| | | $V_{IN} = V_{OUT} = 3.3V$. Hard Short. | | 30 | | ns |

Note 1: Package power dissipation on 1square inch pad, 2 oz copper board.

Typical Characteristics

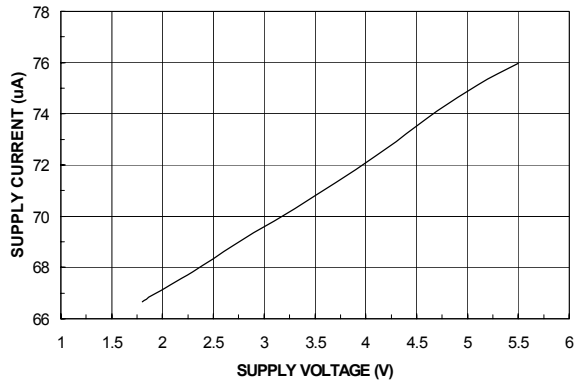

Figure 1. Quiescent Current vs. Input Voltage

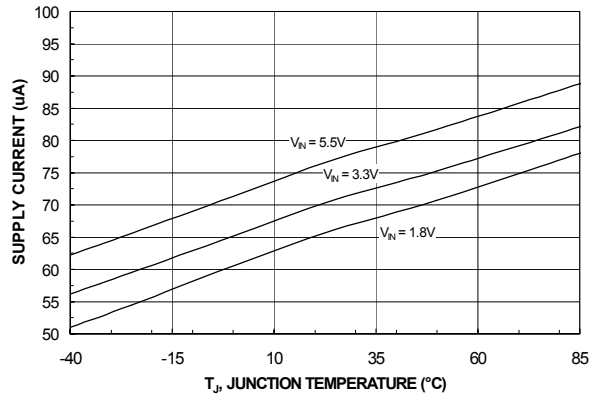

Figure 2. Quiescent Current vs. Temperature

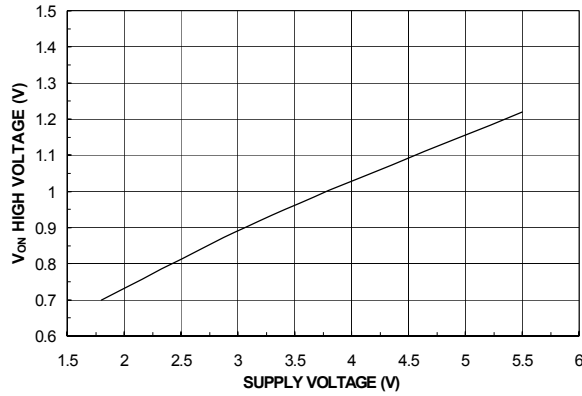

Figure 3. V_{ON} High Voltage vs. Input Voltage

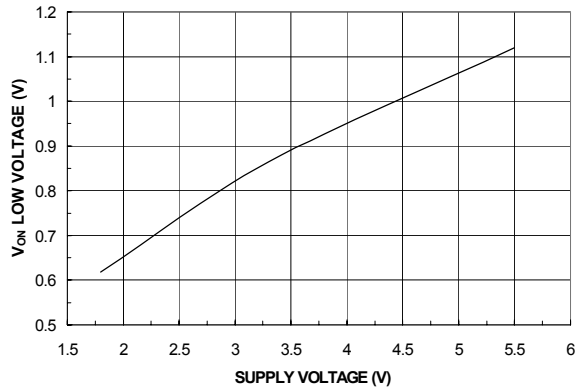

Figure 4. V_{ON} Low Voltage vs. Input Voltage

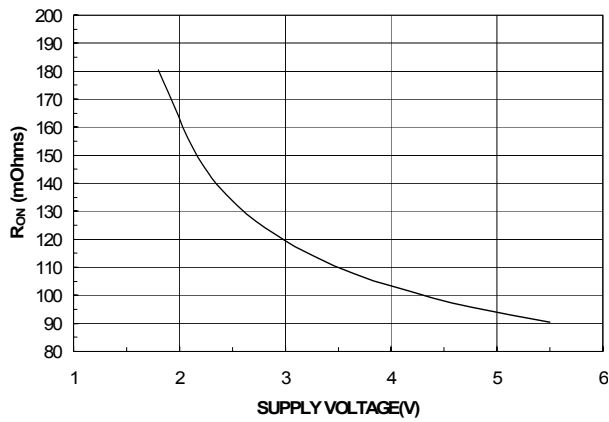

Figure 5. R_{ON} vs. V_{IN}

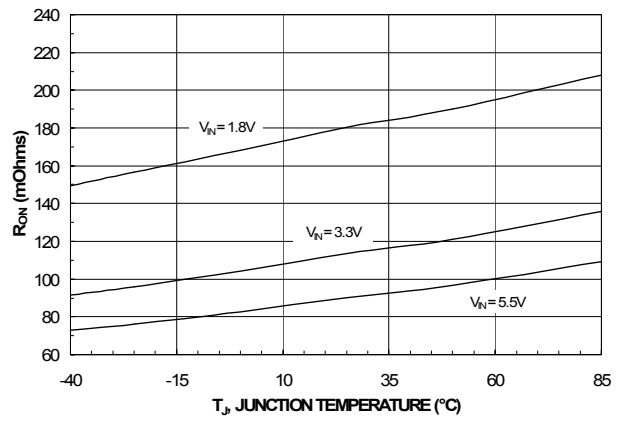

Figure 6. R_{ON} vs. Temperature

Typical Characteristics

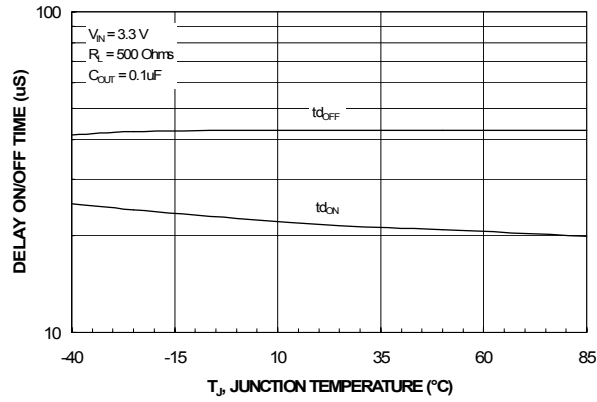

Figure 7. t_{dON} / t_{dOFF} vs. Temperature

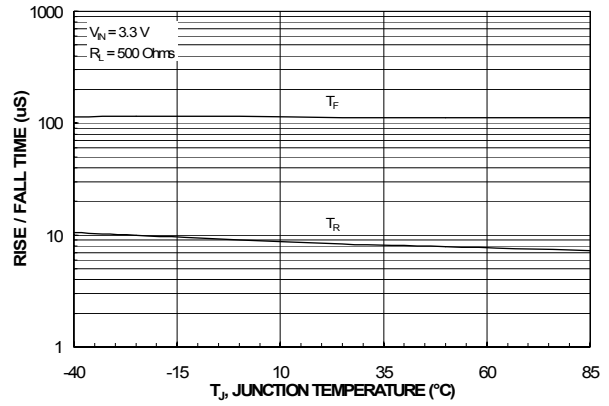

Figure 8. T_{RISE} / T_{FALL} vs. Temperature

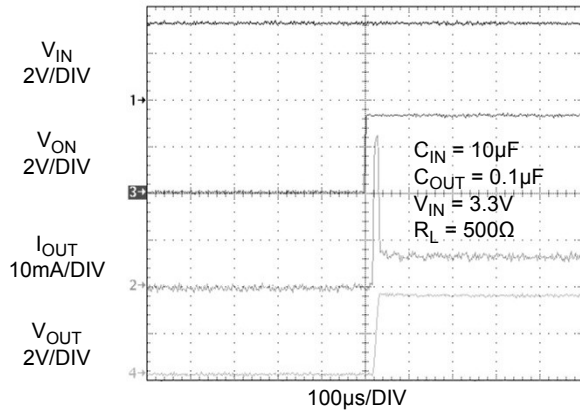

Figure 9. t_{dON} Response

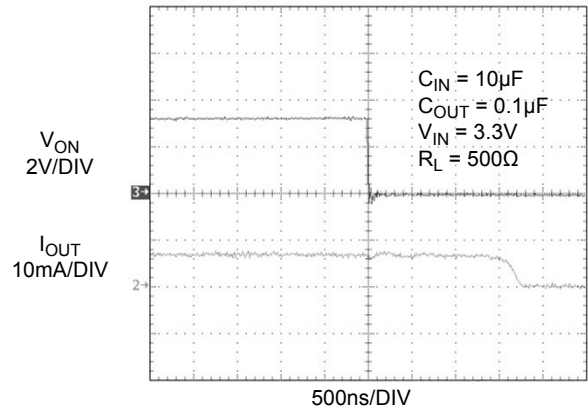

Figure 10. t_{dOFF} Response

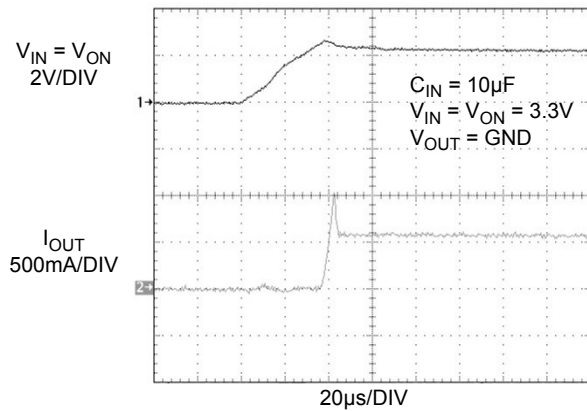

Figure 11. Current Limit Response Time
(Switch is powered into a short)

Description of Operation

The FPF2165R is a current limited switch that protect systems and loads which can be damaged or disrupted by the application of high currents. The core of each device is a 0.12Ω P-channel MOSFET and a controller capable of functioning over a wide input operating range of 1.8-5.5V. The controller protects against system malfunctions through current limiting, undervoltage lockout and thermal shutdown. The current limit is adjustable from 0.15A to 1.5A through the selection of an external resistor.

On/Off Control

The ON pin controls the state of the switch. When ON is high, the switch is in the on state. Activating ON continuously holds the switch in the on state so long as there is no fault. An undervoltage on V_{IN} or a junction temperature in excess of 140°C overrides the ON control to turn off the switch. The FPF2165R does not turn off in response to an over current condition but instead remains operating in a constant current mode so long as ON is active and the thermal shutdown or undervoltage lockout have not activated.

The ON pin control voltage and V_{IN} pin have independent recommended operating ranges. The ON pin voltage can be driven by a voltage level higher than the input voltage.

Fault Reporting

Upon the detection of an over-current, an input undervoltage, or an over-temperature condition, the FLAGB signals the fault mode by activating LO. With the FPF2165R, FLAGB is LO during the faults and immediately returns HI at the end of the fault condition. FLAGB is an open-drain MOSFET which requires a pull-up resistor between VIN and FLAGB. During shutdown, the pull-down on FLAGB is disabled to reduce current draw from the supply.

Current Limiting

The current limit ensures that the current through the switch doesn't exceed a maximum value while not limiting at less than a minimum value. The current at which the parts will limit is adjustable through the selection of an external resistor connected to ISET. Information for selecting the resistor is found in the Application Info section. The FPF2165R has no current limit blanking period so it will remain in a constant current state until the ON pin is deactivated or the thermal shutdown turns-off the switch.

For preventing the switch from large power dissipation during heavy load a short circuit detection feature is introduced. Short circuit condition is detected by observing the output voltage. The switch is put into short circuit current limiting mode if the switch is loaded with a heavy load. When the output voltage drops below VSCTH, short circuit detection threshold voltage, the current limit value re-conditioned and short circuit current limit value is decreased to 62.5% of the current limit value. This keeps the power dissipation of the part below a certain limit even at dead short conditions at 5.5V input voltage. The VSCTH value is set to be 1V. At around 1.1V of output voltage the switch is removed from short circuit current limiting mode and the current limit is set to the current limit value.

Undervoltage Lockout

The undervoltage lockout turns-off the switch if the input voltage drops below the undervoltage lockout threshold. With the ON pin active the input voltage rising above the undervoltage lockout threshold will cause a controlled turn-on of the switch which limits current over-shoots.

Reverse Current Blocking

The FPF2165R family has a Reverse Current Blocking feature that protects input source against current flow from output to input. For a standard USB power design, this is an important feature which protects the USB host from being damaged due to reverse current flow on V_{BUS} . The reverse current blocking feature is active when the load switch is turned off.

If ON pin is LO and output voltage become greater than input voltage, no current can flow from the output to the input. The FLAGB operation is independent of the Reverse Current blocking feature and will not report a fault condition if this feature is activated.

Thermal Shutdown

The thermal shutdown protects the die from internally or externally generated excessive temperatures. During an over-temperature condition the FLAGB is activated and the switch is turned-off. The switch automatically turns-on again if temperature of the die drops below the threshold temperature.

Application Information

Typical Application

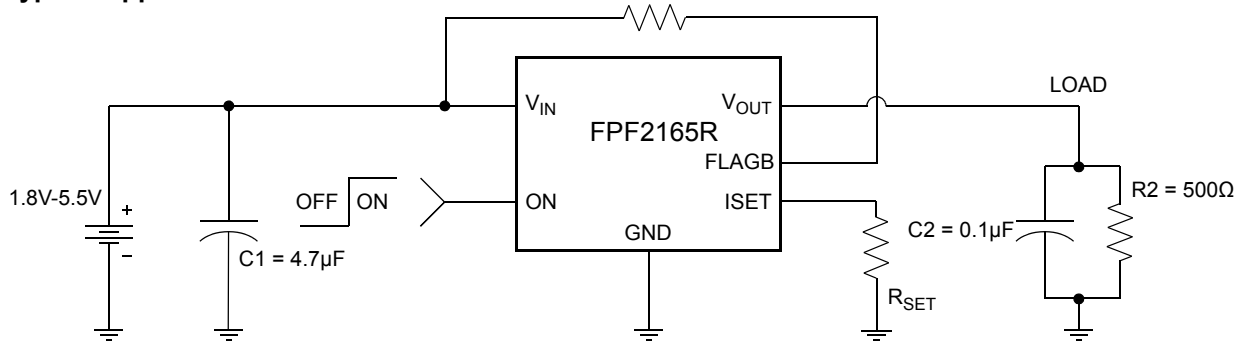

Setting Current Limit

The FPF2165R have a current limit which is set with an external resistor connected between ISET and GND. This resistor is selected by using the following equation,

$$I_{LIM} = 340.1 \times R_{SET}^{-1.0278} \quad (1)$$

The table below can be used to select RSET. A typical application would be the 500mA current that is required by a single USB port. Using the table below an appropriate selection for the RSET resistor would be 570Ω.

Current Limit Various RSET Values

| R _{SET} [Ω] | Min. Current Limit [mA] | Typ. Current Limit [mA] | Max. Current Limit [mA] |
|----------------------|-------------------------|-------------------------|-------------------------|
| 1840 | 135 | 150 | 165 |
| 1391 | 180 | 200 | 220 |
| 937 | 270 | 300 | 330 |
| 708 | 360 | 400 | 440 |
| 632 | 405 | 450 | 495 |
| 570 | 450 | 500 | 550 |
| 478 | 540 | 600 | 660 |
| 411 | 630 | 700 | 770 |
| 361 | 720 | 800 | 880 |
| 322 | 810 | 900 | 990 |
| 290 | 900 | 1000 | 1100 |
| 265 | 990 | 1100 | 1210 |
| 243 | 1080 | 1200 | 1320 |
| 225 | 1170 | 1300 | 1430 |
| 209 | 1260 | 1400 | 1540 |
| 196 | 1350 | 1500 | 1650 |

Input Capacitor

To limit the voltage drop on the input supply caused by transient in-rush currents when the switch is turned on into a discharged load capacitor or a short-circuit, a capacitor needs to be placed between V_{IN} and GND. A 4.7µF ceramic capacitor, C_{IN}, must be placed close to the V_{IN} pin. A higher value of C_{IN} can be used to further reduce the voltage drop experienced as the switch is turned on into a large capacitive load.

Output Capacitor

A 0.1µF capacitor C_{OUT} should be placed between V_{OUT} and GND. This capacitor will prevent parasitic board inductances from forcing V_{OUT} below GND when the switch turns-off.

Power Dissipation

During normal operation as a switch, the power dissipated in the part will depend upon the level at which the current limit is set. The maximum allowed setting for the current limit is 0.77A and this will result in a power dissipation of,

$$P = (I_{LIM})^2 \times R_{DS} = (0.77)^2 \times 0.12 = 71.148mW \quad (2)$$

If the part goes into current limit the maximum power dissipation will occur when the output is shorted to ground. This is more power than the package can dissipate, but the thermal shutdown of the part will activate to protect the part from damage due to excessive heating. A short on the output will cause the part to operate in a constant current state dissipating a worst case power of,

$$P(max) = V_{IN(max)} \times I_{LIM(max)} \quad (3)$$

$$= 5.5 \times 0.77 = 4.235W$$

This large amount of power will activate the thermal shutdown and the part will cycle in and out of thermal shutdown so long as the ON pin is active and the short is present.

Board Layout

For best performance, all traces should be as short as possible. To be most effective, the input and output capacitors should be placed close to the device to minimize the effects that parasitic trace inductances may have on normal and short-circuit operation. Using wide traces for V_{IN} , V_{OUT} and GND will help minimize parasitic electrical effects along with minimizing the case to ambient thermal impedance.

The middle pad (pin 7) should be connected to the GND plate of PCB for improving thermal performance of the load switch. An improper layout could result higher junction temperature and triggering the thermal shutdown protection feature. This concern applies when the switch is set at higher current limit value and an overcurrent condition occurs. In this case power dissipation of the switch ($P_D = (V_{IN} - V_{OUT}) \times I_{LIM(max)}$) could exceed the maximum absolute power dissipation of 1.2W.

Dimensional Outline and Pad Layout

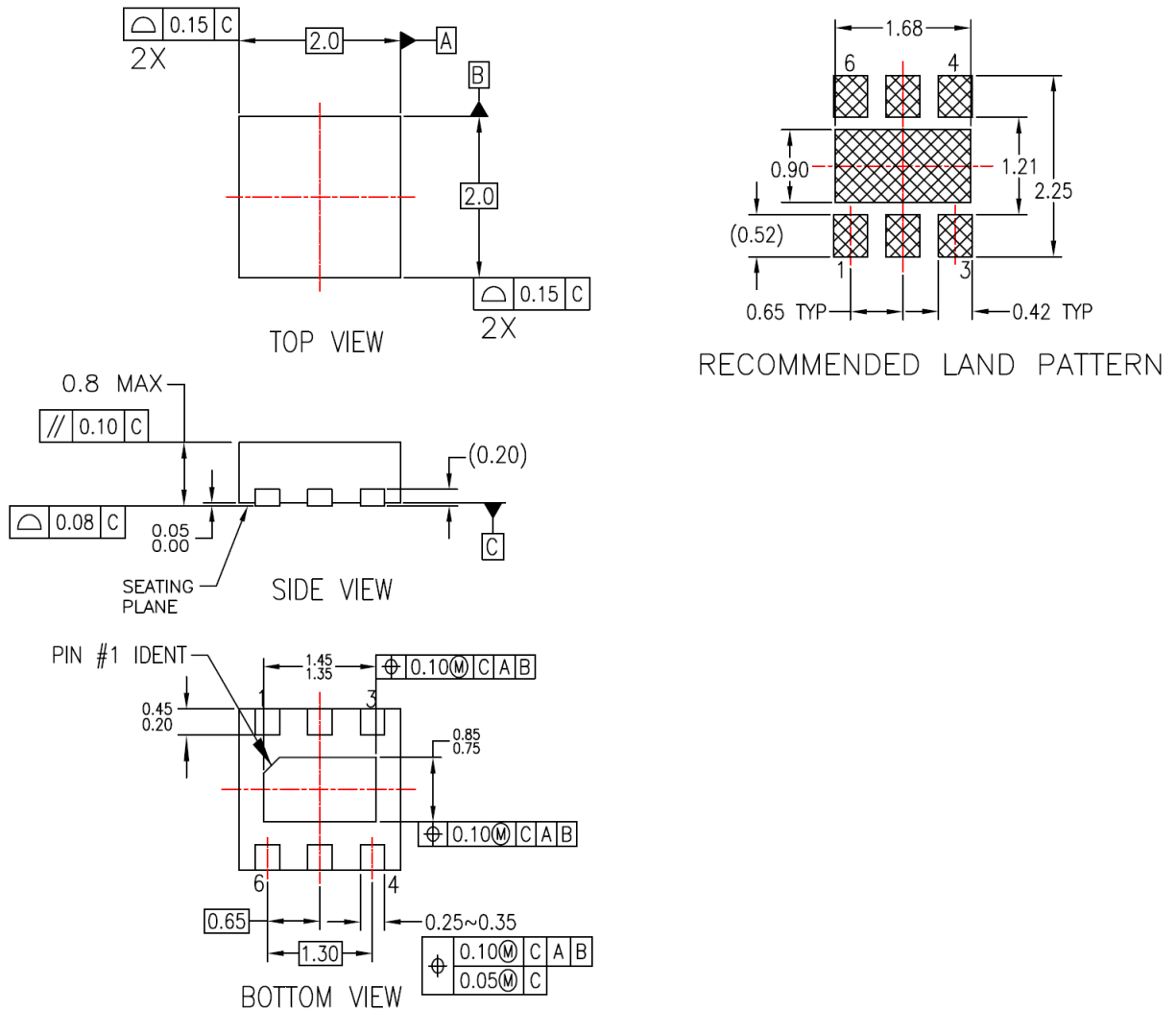

NOTES:







- A. NON-CONFORMS TO JEDEC REGISTRATION,
- B. DIMENSIONS ARE IN MILLIMETERS.
- C. DIMENSIONS AND TOLERANCES PER ASME Y14.5M, 1994

MLP06KrevA



TRADEMARKS

The following includes registered and unregistered trademarks and service marks, owned by Fairchild Semiconductor and/or its global subsidiaries, and is not intended to be an exhaustive list of all such trademarks.

- | | | | |
|--|---|--|---|
| Auto-SPM™ | F-PFS™ | PowerTrench® | The Power Franchise® |
| Build it Now™ | FRFET® | PowerXS™ | the power™ |
| CorePLUS™ | Global Power ResourceSM | Programmable Active Droop™ | franchise™ |
| CorePOWER™ | Green FPS™ | QFET® | TinyBoost™ |
| CROSSVOLT™ | Green FPS™ e-Series™ | QS™ | TinyBuck™ |
| CTL™ | Gmax™ | Quiet Series™ | TinyLogic® |
| Current Transfer Logic™ | GTO™ | RapidConfigure™ | TINYOPTO™ |
| EcoSPARK® | IntelliMAX™ |  ™ | TinyPower™ |
| EfficientMax™ | ISOPLANAR™ | Saving our world, 1mW/W/kW at a time™ | TinyPWM™ |
| EZSWITCH™* | MegaBuck™ | SmartMax™ | TinyWire™ |
|  ™* | MICROCOUPLER™ | SMART START™ | TriFault Detect™ |
|  ™ | MicroFET™ | SPM® | TRUECURRENT™* |
| Fairchild® | MicroPak™ | STEALTH™ | μSerDes™ |
| Fairchild Semiconductor® | MillerDrive™ | SuperFET™ |  ™ |
| FACT Quiet Series™ | MotionMax™ | SuperSOT™-3 | UHC® |
| FACT® | Motion-SPM™ | SuperSOT™-6 | Ultra FRFET™ |
| FAST® | OPTOLOGIC® | SuperSOT™-8 | UniFET™ |
| FastvCore™ | OPTOPLANAR® | SupreMOS™ | VCX™ |
| FETBench™ |  ™ | SyncFET™ | VisualMax™ |
| FlashWriter®* | PDP SPM™ | Sync-Lock™ | XS™ |
| FPS™ | Power-SPM™ |  ™* | |

* Trademarks of System General Corporation, used under license by Fairchild Semiconductor.

DISCLAIMER

FAIRCHILD SEMICONDUCTOR RESERVES THE RIGHT TO MAKE CHANGES WITHOUT FURTHER NOTICE TO ANY PRODUCTS HEREIN TO IMPROVE RELIABILITY, FUNCTION, OR DESIGN. FAIRCHILD DOES NOT ASSUME ANY LIABILITY ARISING OUT OF THE APPLICATION OR USE OF ANY PRODUCT OR CIRCUIT DESCRIBED HEREIN; NEITHER DOES IT CONVEY ANY LICENSE UNDER ITS PATENT RIGHTS, NOR THE RIGHTS OF OTHERS. THESE SPECIFICATIONS DO NOT EXPAND THE TERMS OF FAIRCHILD'S WORLDWIDE TERMS AND CONDITIONS, SPECIFICALLY THE WARRANTY THEREIN, WHICH COVERS THESE PRODUCTS.

LIFE SUPPORT POLICY

FAIRCHILD'S PRODUCTS ARE NOT AUTHORIZED FOR USE AS CRITICAL COMPONENTS IN LIFE SUPPORT DEVICES OR SYSTEMS WITHOUT THE EXPRESS WRITTEN APPROVAL OF FAIRCHILD SEMICONDUCTOR CORPORATION.

As used herein:

- Life support devices or systems are devices or systems which, (a) are intended for surgical implant into the body or (b) support or sustain life, and (c) whose failure to perform when properly used in accordance with instructions for use provided in the labeling, can be reasonably expected to result in a significant injury of the user.
- A critical component in any component of a life support, device, or system whose failure to perform can be reasonably expected to cause the failure of the life support device or system, or to affect its safety or effectiveness.

ANTI-COUNTERFEITING POLICY

Fairchild Semiconductor Corporation's Anti-Counterfeiting Policy. Fairchild's Anti-Counterfeiting Policy is also stated on our external website, www.fairchildsemi.com, under Sales Support.

Counterfeiting of semiconductor parts is a growing problem in the industry. All manufacturers of semiconductor products are experiencing counterfeiting of their parts. Customers who inadvertently purchase counterfeit parts experience many problems such as loss of brand reputation, substandard performance, failed applications, and increased cost of production and manufacturing delays. Fairchild is taking strong measures to protect ourselves and our customers from the proliferation of counterfeit parts. Fairchild strongly encourages customers to purchase Fairchild parts either directly from Fairchild or from Authorized Fairchild Distributors who are listed by country on our web page cited above. Products customers buy either from Fairchild directly or from Authorized Fairchild Distributors are genuine parts, have full traceability, meet Fairchild's quality standards for handling and storage and provide access to Fairchild's full range of up-to-date technical and product information. Fairchild and our Authorized Distributors will stand behind all warranties and will appropriately address any warranty issues that may arise. Fairchild will not provide any warranty coverage or other assistance for parts bought from Unauthorized Sources. Fairchild is committed to combat this global problem and encourage our customers to do their part in stopping this practice by buying direct or from authorized distributors.

PRODUCT STATUS DEFINITIONS

Definition of Terms

| Datasheet Identification | Product Status | Definition |
|--------------------------|-----------------------|---|
| Advance Information | Formative / In Design | Datasheet contains the design specifications for product development. Specifications may change in any manner without notice. |
| Preliminary | First Production | Datasheet contains preliminary data; supplementary data will be published at a later date. Fairchild Semiconductor reserves the right to make changes at any time without notice to improve design. |
| No Identification Needed | Full Production | Datasheet contains final specifications. Fairchild Semiconductor reserves the right to make changes at any time without notice to improve the design. |
| Obsolete | Not In Production | Datasheet contains specifications on a product that is discontinued by Fairchild Semiconductor. The datasheet is for reference information only. |

Rev. I40