



ELECTROSTATIC SENSITIVE DEVICE
OBSERVE HANDLING PRECAUTIONS

MITSUBISHI RF POWER MOS FET

RD06HVF1

RoHS Compliance, Silicon MOSFET Power Transistor 175MHz,6W

DESCRIPTION

RD06HVF1 is a MOS FET type transistor specifically designed for VHF RF power amplifiers applications.

FEATURES

High power gain:
Pout>6W, Gp>13dB @Vdd=12.5V,f=175MHz

APPLICATION

For output stage of high power amplifiers in VHF band mobile radio sets.

RoHS COMPLIANT

RD06HVF1-101 is a RoHS compliant products. RoHS compliance is indicate by the letter "G" after the lot marking.

This product include the lead in high melting temperature type solders.

How ever,it applicable to the following exceptions of RoHS Directions.

- 1.Lead in high melting temperature type solders(i.e.tin-lead solder alloys containing more than85% lead.)

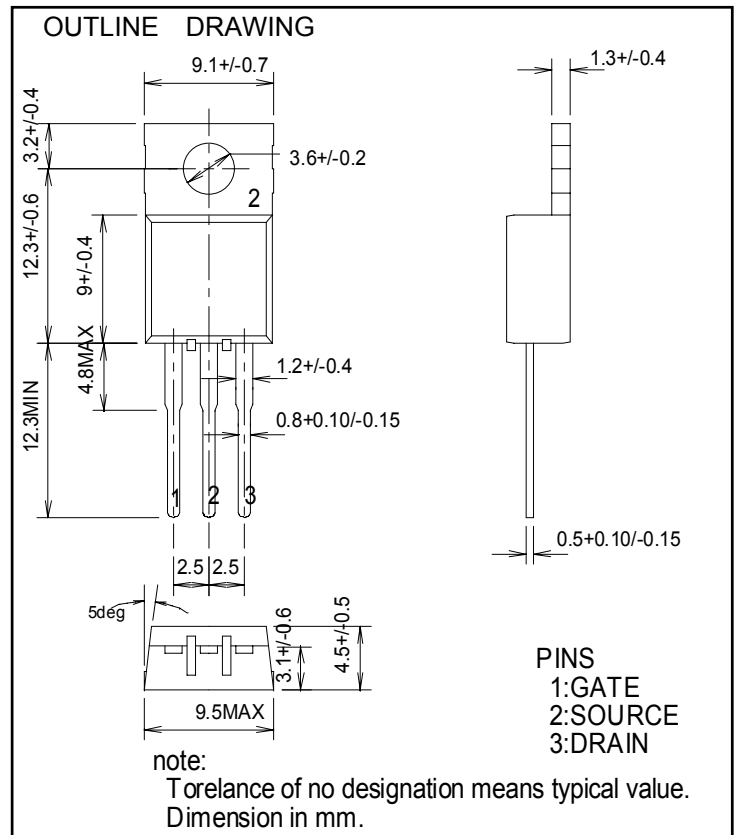



ELECTROSTATIC SENSITIVE DEVICE
OBSERVE HANDLING PRECAUTIONS

MITSUBISHI RF POWER MOS FET

RD06HVF1

RoHS Compliance, Silicon MOSFET Power Transistor 175MHz,6W

ABSOLUTE MAXIMUM RATINGS

(T_c=25°C UNLESS OTHERWISE NOTED)

SYMBOL	PARAMETER	CONDITIONS	RATINGS	UNIT
V _{DSS}	Drain to source voltage	V _{GS} =0V	50	V
V _{GSS}	Gate to source voltage	V _{DS} =0V	+/- 20	V
P _{ch}	Channel dissipation	T _c =25°C	27.8	W
P _{in}	Input power	Z _g =Z _l =50Ω	0.6	W
I _D	Drain current	-	3	A
T _{ch}	Channel temperature	-	150	°C
T _{stg}	Storage temperature	-	-40 to +150	°C
R _{th j-c}	Thermal resistance	junction to case	4.5	°C/W

Note 1: Above parameters are guaranteed independently.

ELECTRICAL CHARACTERISTICS

(T_c=25°C, UNLESS OTHERWISE NOTED)

SYMBOL	PARAMETER	CONDITIONS	LIMITS			UNIT
			MIN	TYP	MAX.	
I _{DSS}	Zero gate voltage drain current	V _{DS} =17V, V _{GS} =0V	-	-	10	μA
I _{GSS}	Gate to source leak current	V _{GS} =10V, V _{DS} =0V	-	-	1	μA
V _{TH}	Gate threshold Voltage	V _{DS} =12V, I _{DS} =1mA	1.9	-	4.9	V
P _{out}	Output power	V _{DD} =12.5V, P _{in} =0.3W, f=175MHz, I _{dq} =0.3A	6	10	-	W
η _D	Drain efficiency		60	65	-	%
	Load VSWR tolerance	V _{DD} =15.2V, P _o =6W(Pin Control) f=175MHz, I _{dq} =0.3A, Z _g =50Ω Load VSWR=20:1(All Phase)	No destroy			-

Note : Above parameters , ratings , limits and conditions are subject to change.



ELECTROSTATIC SENSITIVE DEVICE
OBSERVE HANDLING PRECAUTIONS

MITSUBISHI RF POWER MOS FET

RD06HVF1

RoHS Compliance, Silicon MOSFET Power Transistor 175MHz,6W

TYPICAL CHARACTERISTICS

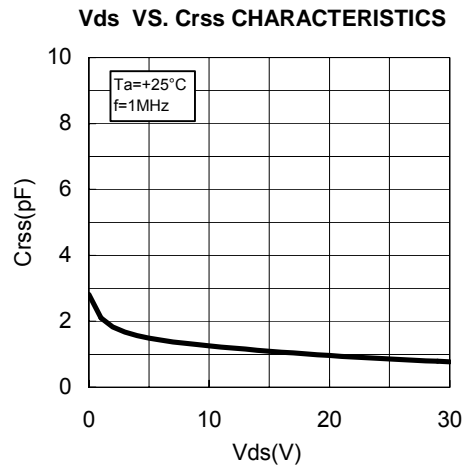
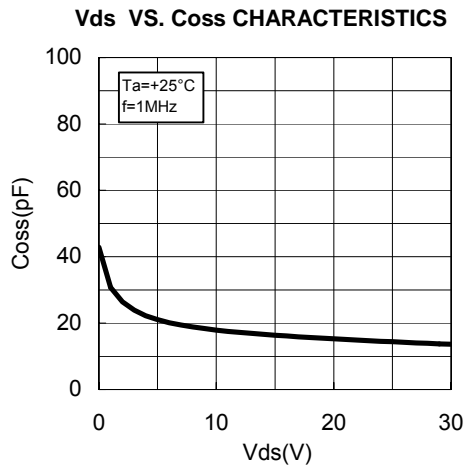
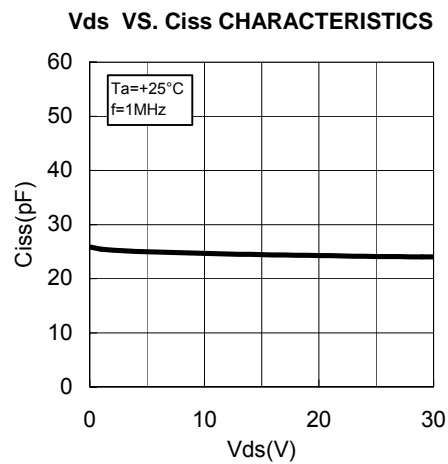
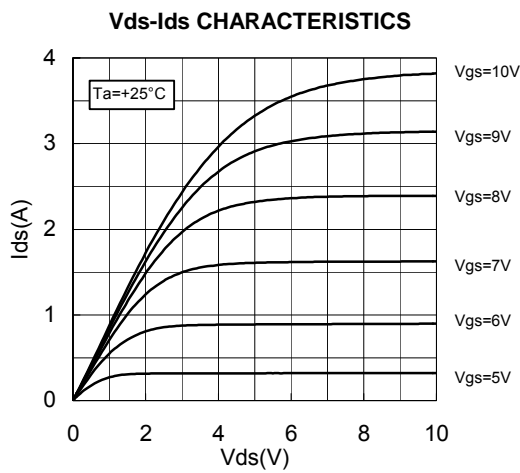
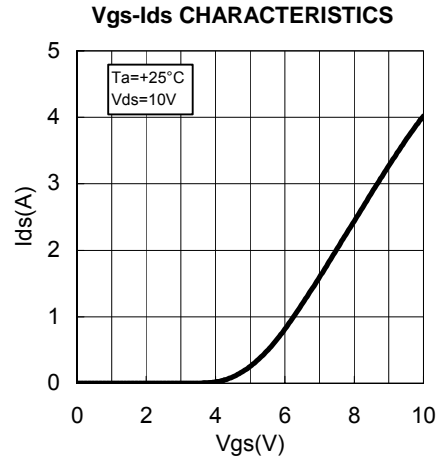
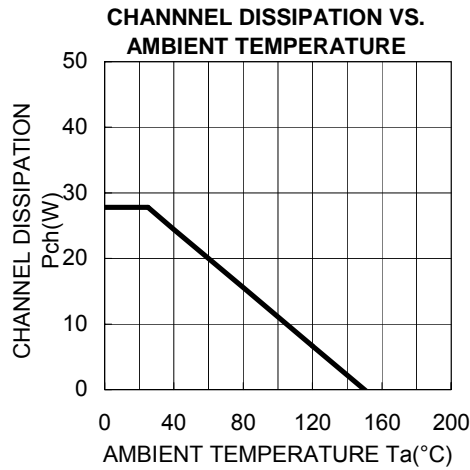



ELECTROSTATIC SENSITIVE DEVICE
OBSERVE HANDLING PRECAUTIONS

MITSUBISHI RF POWER MOS FET

RD06HVF1

RoHS Compliance, Silicon MOSFET Power Transistor 175MHz,6W

TYPICAL CHARACTERISTICS

Pin-Po CHARACTERISTICS

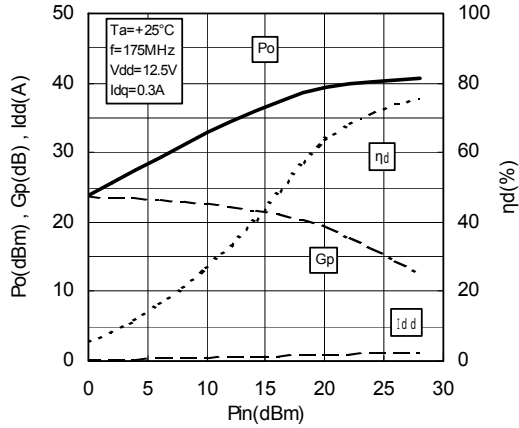

Pin-Po CHARACTERISTICS

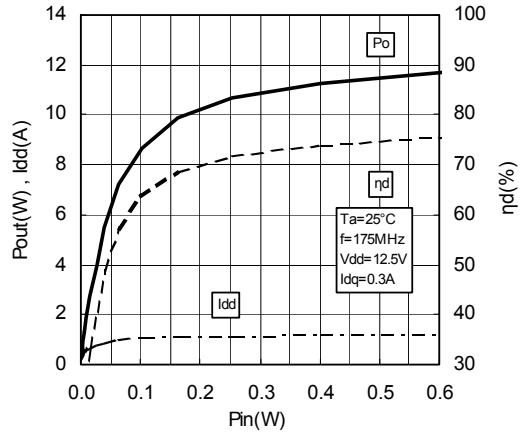

Vdd-Po CHARACTERISTICS

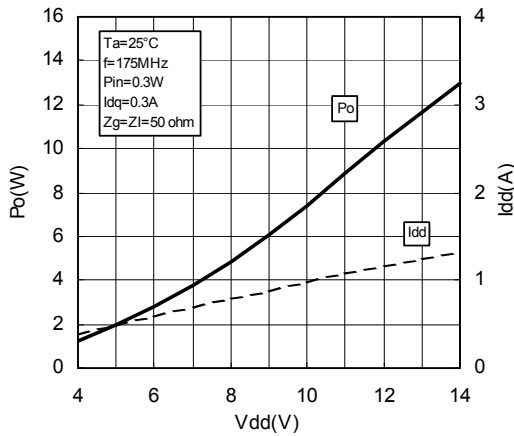

Vgs-Ids CHARACTERISTICS 2

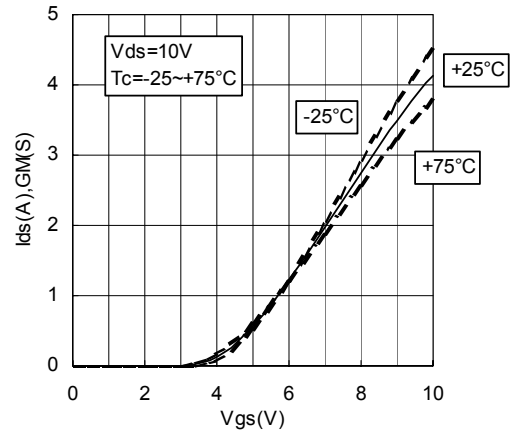

Vgs-gm CHARACTERISTICS

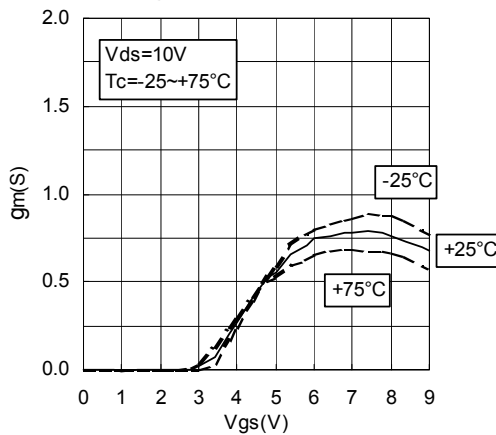



ELECTROSTATIC SENSITIVE DEVICE
OBSERVE HANDLING PRECAUTIONS

MITSUBISHI RF POWER MOS FET

RD06HVF1

RoHS Compliance, Silicon MOSFET Power Transistor 175MHz,6W

TEST CIRCUIT(f=175MHz)

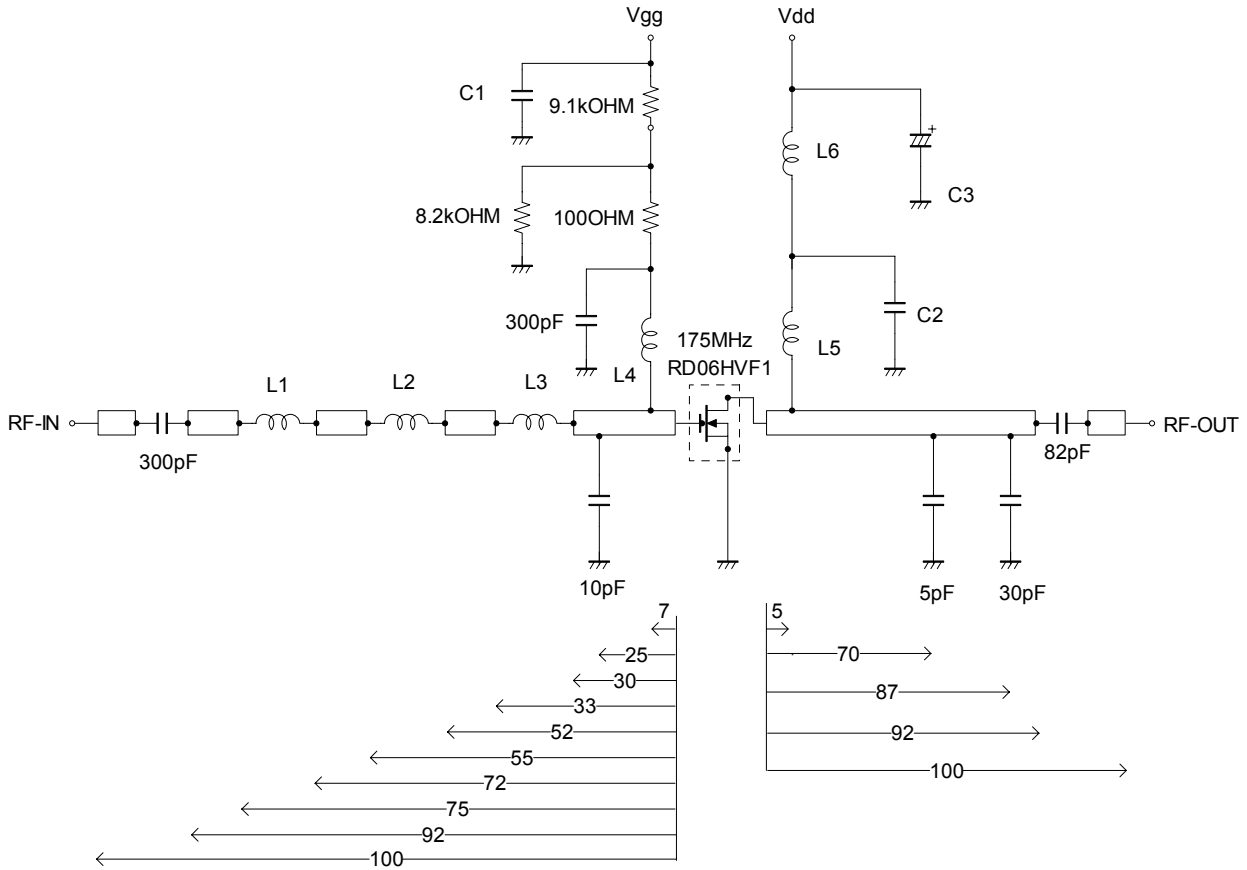

- C1:2200pF 10uF in parallel
- C2:2200pF*2 in parallel
- C3:2200pF,330uF in parallel

- L1-L3:6Turns,I.D1.6mm,D0.4mm enameled copper wire
- L4:1Turns,I.D6mm,D1.6mm silver plateted copper wire
- L5:4Turns,I.D6mm,D1.6mm P=1 silver plateted copper wire
- L6:4Turns,I.D6mm,D1.6mm P=1 silver plateted copper wire

Note:Board material-Teflon substrate
micro strip line width=4.2mm/50OHM,er:2.7,t=1.6mm
Dimensions:mm



ELECTROSTATIC SENSITIVE DEVICE
OBSERVE HANDLING PRECAUTIONS

MITSUBISHI RF POWER MOS FET

RD06HVF1

RoHS Compliance, Silicon MOSFET Power Transistor 175MHz,6W

INPUT/OUTPUT IMPEDANCE VS.FREQUENCY CHARACTERISTICS

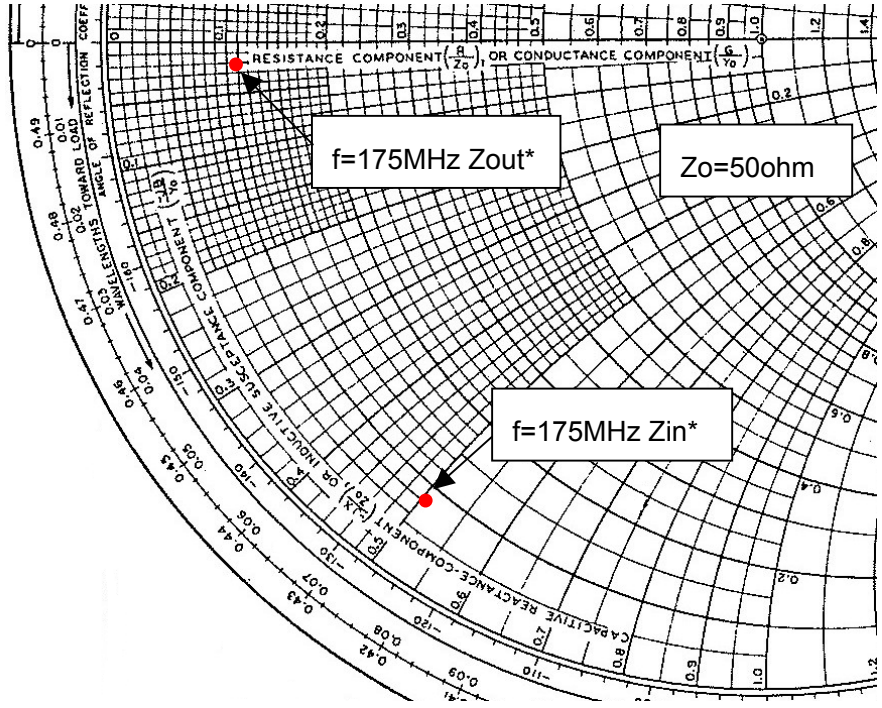

Zin , Zout

f	Zin	Zout	Conditions
(MHz)	(ohm)	(ohm)	
175	4.25-j25.6	5.64-j1.05	Po=10W, Vdd=12.5V, Pin=0.3W



ELECTROSTATIC SENSITIVE DEVICE
OBSERVE HANDLING PRECAUTIONS

MITSUBISHI RF POWER MOS FET

RD06HVF1

RoHS Compliance, Silicon MOSFET Power Transistor 175MHz,6W

RD06HVF1 S-PARAMETER DATA (@Vdd=12.5V, Id=500mA)

Freq. [MHz]	S11		S21		S12		S22	
	(mag)	(ang)	(mag)	(ang)	(mag)	(ang)	(mag)	(ang)
10	0.985	-18.8	34.407	165.9	0.008	76.2	0.826	-17.3
30	0.900	-50.4	30.427	143.3	0.021	59.4	0.767	-43.6
50	0.799	-74.4	24.979	126.1	0.029	43.2	0.677	-65.0
100	0.667	-109.6	15.565	100.7	0.032	27.3	0.547	-96.8
150	0.636	-129.0	10.953	85.1	0.032	23.1	0.523	-113.4
200	0.630	-140.1	8.194	73.7	0.029	25.3	0.528	-124.7
250	0.645	-148.2	6.528	63.9	0.027	34.5	0.561	-132.7
300	0.663	-155.0	5.315	55.2	0.027	49.1	0.588	-139.6
350	0.685	-160.7	4.437	47.4	0.031	61.8	0.622	-145.9
400	0.708	-165.9	3.771	39.9	0.039	71.0	0.657	-151.7
450	0.729	-170.8	3.233	33.2	0.048	75.8	0.686	-157.0
500	0.752	-175.4	2.826	26.8	0.059	77.9	0.715	-162.3
550	0.771	-179.9	2.475	20.7	0.070	76.9	0.743	-167.6
600	0.789	-175.4	2.186	15.2	0.083	76.1	0.763	-172.3
650	0.804	-171.2	1.943	9.7	0.095	73.7	0.789	-177.3
700	0.819	-166.9	1.738	4.6	0.108	71.0	0.804	-178.1
750	0.834	-162.6	1.560	0.0	0.120	68.1	0.820	-173.5
800	0.842	-158.5	1.410	-4.5	0.133	65.0	0.837	-169.0
850	0.851	-154.3	1.275	-8.7	0.145	61.6	0.847	-164.8
900	0.859	-150.3	1.160	-12.6	0.157	58.2	0.858	-160.2
950	0.866	-146.2	1.058	-16.9	0.167	54.5	0.869	-155.7
1000	0.870	-142.3	0.963	-20.0	0.179	51.0	0.876	-151.8



ELECTROSTATIC SENSITIVE DEVICE
OBSERVE HANDLING PRECAUTIONS

MITSUBISHI RF POWER MOS FET

RD06HVF1

RoHS Compliance, Silicon MOSFET Power Transistor 175MHz,6W

—Keep safety first in your circuit designs! —

Mitsubishi Electric Corporation puts the maximum effort into making semiconductor products better and more reliable, but there is always the possibility that trouble may occur with them. Trouble with semiconductors may lead to personal injury, fire or property damage. Remember to give due consideration to safety when making your circuit designs, with appropriate measures such as (i) placement of substitutive, auxiliary circuits, (ii) use of non-flammable material or (iii) prevention against any malfunction or mishap.

warning !

Do not use the device at the exceeded the maximum rating condition. In case of plastic molded devices, the exceeded maximum rating condition may cause blowout, smoldering or catch fire of the molding resin due to extreme short current flow between the drain and the source of the device. These results causes in fire or injury.