

ULN2074, ULN2075 QUADRUPLE HIGH-CURRENT DARLINGTON SWITCHES

D2580, MAY 1980—REVISED SEPTEMBER 1986

- Output Collector Current . . . 1.5 A Max
- 2-W Dissipation Rating
- High Output-Voltage Capability
- Output Sink- or Source-Current Capabilities
- Input Compatible with TTL or 5-V CMOS
- Designed for Interchangeability with Sprague ULN2074 and ULN2075

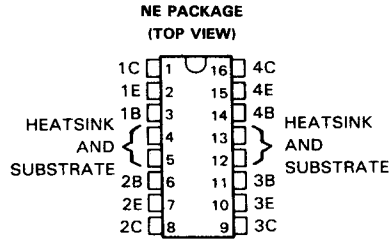

description

The ULN2074 and ULN2075 are monolithic, quadruple, high-voltage, high-current n-p-n darlington-transistor amplifier devices. They feature high-voltage outputs with collector-current ratings of 1.5 A for each Darlington pair.

The ULN2074 and ULN2075 are unique general-purpose devices, each featuring uncommitted collectors and emitters to allow for either sinking or sourcing the output current. These devices offer the system designer the flexibility of tailoring the circuit to the application. Typical applications include logic buffers, relay drivers, lamp drivers, and hammer drivers.

For proper operation, the substrate must be connected to the most negative voltage.

The ULN2074 and ULN2075 are characterized for operation from -20°C to 85°C .

schematic (each switch)

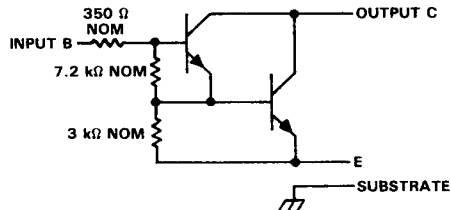

logic symbol†

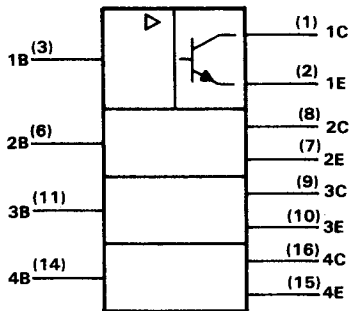

† This symbol is in accordance with ANSI/IEEE Std 91-1984 and IEC Publication 617-12.

PRODUCTION DATA documents contain information current as of publication date. Products conform to specifications per the terms of Texas Instruments standard warranty. Production processing does not necessarily include testing of all parameters.

TEXAS
INSTRUMENTS

POST OFFICE BOX 655303 • DALLAS, TEXAS 75265

Copyright © 1986, Texas Instruments Incorporated

4-175

ULN2074, ULN2075 QUADRUPLE HIGH-CURRENT DARLINGTON SWITCHES

absolute maximum ratings at 25 °C free-air temperature for each switch (unless otherwise noted)

	ULN2074	ULN2075	UNIT
Collector-emitter voltage	50	80	V
Input voltage with respect to substrate	30	60	V
Peak collector current (see Figures 9, 10, and 11)	1.5	1.5	A
Input current	25	25	mA
Total power dissipation at (or below) 25 °C free-air temperature (see Note 1)	2075	2075	mW
Operating free-air temperature range	-20 to 85	-20 to 85	°C
Storage temperature range	-55 to 150	-55 to 150	°C
Lead temperature 1,6 mm (1/16 inch) from the case for 10 seconds	260	260	°C

NOTE 1: For operation above 25 °C free-air temperature, derate total power linearly to 1079 mW at 85 °C at the rate of 16.6 mW/°C.

electrical characteristics at 25 °C free-air temperature (unless otherwise noted)

PARAMETER	TEST FIGURE	TEST CONDITIONS	ULN2074		ULN2075		UNIT
			MIN	MAX	MIN	MAX	
V _{CE(sus)} Collector sustaining voltage	1	V _I = 0.4 V, I _C = 100 mA	35		50		V
I _{CEX} Collector output cutoff current	2	V _{CE} = 50 V		100			μA
		V _{CE} = 50 V, T _A = 70 °C		500			
		V _{CE} = 80 V				100	
I _{I(on)} On-state input current	3	V _I = 2.4 V	2	4.3	2	4.3	mA
		V _I = 3.75 V	4.5	9.6	4.5	9.6	
V _{I(on)} On-state input voltage	4	V _{CE} = 2 V, I _C = 1 A		2		2	V
		V _{CE} = 2 V, I _C = 1.5 A, See Note 2		2.5		2.5	
V _{CE(sat)} Collector-emitter saturation voltage	5	I _I = 625 μA, I _C = 500 mA		1.1		1.1	V
		I _I = 935 μA, I _C = 750 mA		1.2		1.2	
		I _I = 1.25 mA, I _C = 1 A		1.3		1.3	
		I _I = 2 mA, I _C = 1.25 A, See Note 2		1.4			
		I _I = 2.25 mA, I _C = 1.5 A, See Note 2				1.5	

NOTE 2: These parameters must be measured on one output at a time using pulse techniques, t_w = 10 ms, duty cycle ≤ 10%.

switching characteristics at 25 °C free-air temperature, V_{CC} = 5 V

PARAMETER	TEST CONDITIONS	MIN	TYP	MAX	UNIT
t _{PLH} Propagation delay time, low-to-high-level output	See Figure 6			1	μs
t _{PHL} Propagation delay time, high-to-low-level output				1.5	μs

ULN2074, ULN2075
QUADRUPLE HIGH-CURRENT DARLINGTON SWITCHES

PARAMETER MEASUREMENT INFORMATION

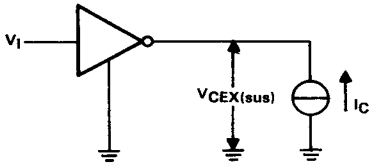

FIGURE 1. $V_{CEX(sus)}$

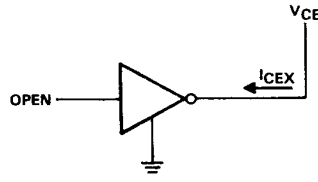

FIGURE 2. I_{CEX}

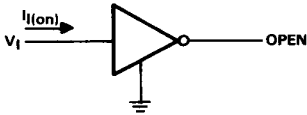

FIGURE 3. $I_{i(on)}$

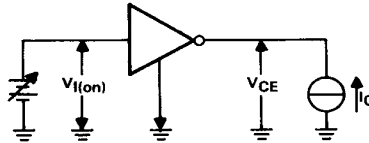

FIGURE 4. $V_{i(on)}$

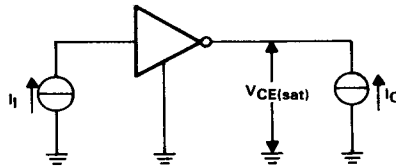
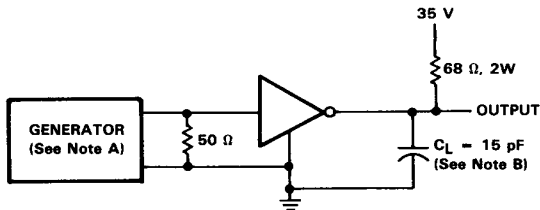
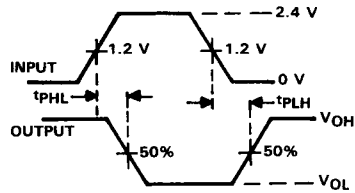

FIGURE 5. $V_{CE(sat)}$



TEST CIRCUITS



VOLTAGE WAVEFORMS

NOTES: A. The input pulse is supplied by a generator having the following characteristics: PRR = 50 kHz, duty cycle = 10%, $Z_0 = 50 \Omega$.
B. C_L includes all probe and stray capacitance.

FIGURE 6. SWITCHING CHARACTERISTICS



POST OFFICE BOX 655303 • DALLAS, TEXAS 75265

4-177

ULN2074, ULN2075 QUADRUPLE HIGH-CURRENT DARLINGTON SWITCHES

ELECTRICAL CHARACTERISTICS

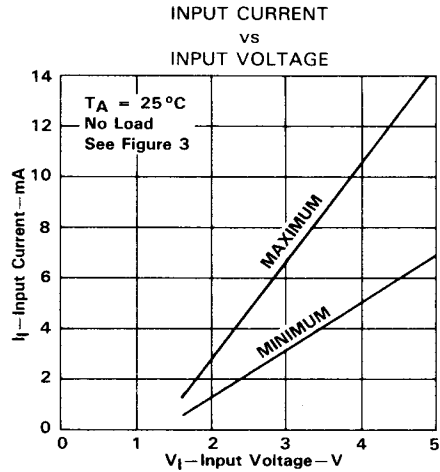

FIGURE 7

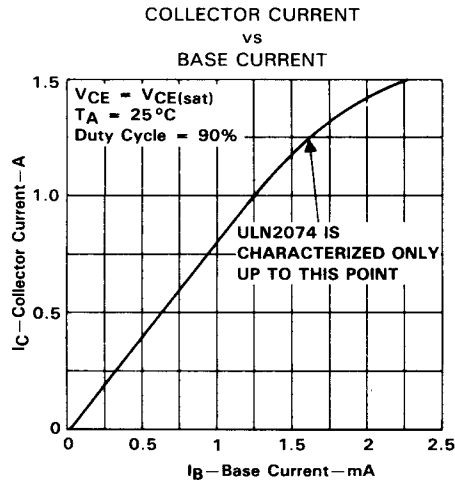

FIGURE 8

THERMAL INFORMATION

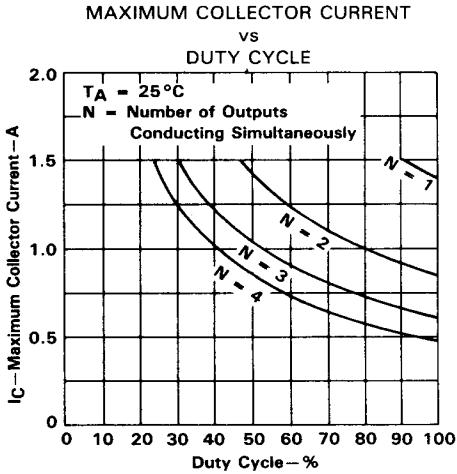

FIGURE 9

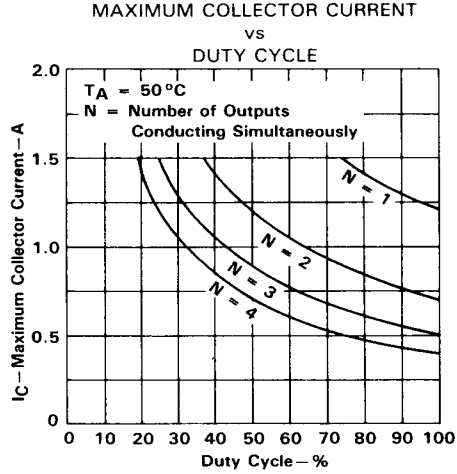

FIGURE 10

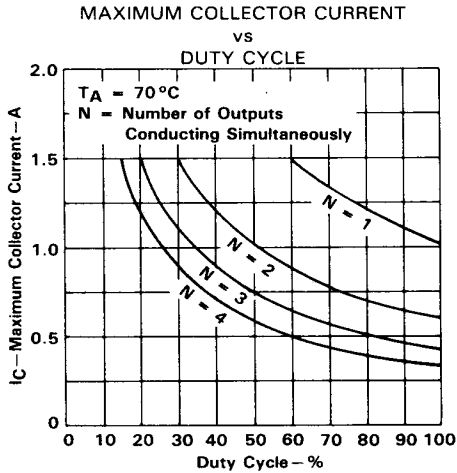

FIGURE 11



POST OFFICE BOX 655303 • DALLAS, TEXAS 75265

**ULN2074, ULN2075
QUADRUPLE HIGH-CURRENT DARLINGTON SWITCHES**

APPLICATION INFORMATION

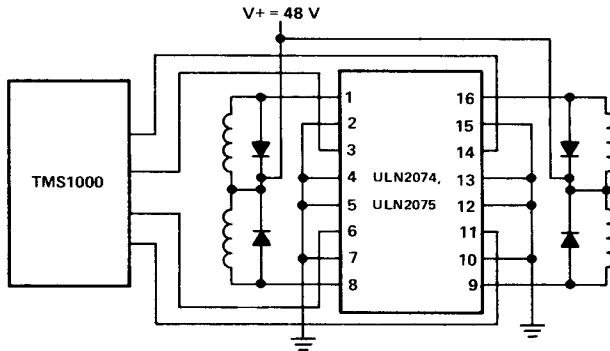

FIGURE 12. RELAY DRIVER INTERFACE WITH EXTERNAL CLAMP DIODES