

Technische Information / Technical Information

IGBT-Module
IGBT-Modules

FP75R12KE3

eupec

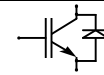

Vorläufige Daten
Preliminary data

Elektrische Eigenschaften / Electrical properties

Höchstzulässige Werte / Maximum rated values

Diode Gleichrichter/ Diode Rectifier

Periodische Rückw. Spitzensperrspannung repetitive peak reverse voltage		V_{RRM}	1600	V
Gleichrichter Ausgang Grenzeffektivstrom maximum RMS current at Rectifier output		I_{RMSmax}	t.b.d.	A
Dauergleichstrom DC forward current	$T_C = 80^\circ\text{C}$	I_d	75	A
Stoßstrom Grenzwert surge forward current	$t_p = 10\text{ ms}, T_{vj} = 25^\circ\text{C}$	I_{FSM}	500	A
	$t_p = 10\text{ ms}, T_{vj} = 150^\circ\text{C}$		400	A
Grenzlastintegral I^2t - value	$t_p = 10\text{ ms}, T_{vj} = 25^\circ\text{C}$	I^2t	1250	A^2s
	$t_p = 10\text{ ms}, T_{vj} = 150^\circ\text{C}$		800	A^2s

Transistor Wechselrichter/ Transistor Inverter

Kollektor-Emitter-Sperrspannung collector-emitter voltage		V_{CES}	1200	V
Kollektor-Dauergleichstrom DC-collector current	$T_C = 80^\circ\text{C}$	$I_{C,nom.}$ I_C	75	A
	$T_C = 25^\circ\text{C}$		105	A
Periodischer Kollektor Spitzenstrom repetitive peak collector current	$t_p = 1\text{ ms}, T_C = 80^\circ\text{C}$	I_{CRM}	150	A
Gesamt-Verlustleistung total power dissipation	$T_C = 25^\circ\text{C}$	P_{tot}	350	W
Gate-Emitter-Spitzenspannung gate-emitter peak voltage		V_{GES}	+/- 20V	V

Diode Wechselrichter/ Diode Inverter

Dauergleichstrom DC forward current	$T_C = 80^\circ\text{C}$	I_F	75	A
Periodischer Spitzenstrom repetitive peak forw. current	$t_p = 1\text{ ms}$	I_{FRM}	150	A
Grenzlastintegral I^2t - value	$V_R = 0\text{V}, t_p = 10\text{ms}, T_{vj} = 125^\circ\text{C}$	I^2t	1.190	A^2s

Transistor Brems-Chopper/ Transistor Brake-Chopper

Kollektor-Emitter-Sperrspannung collector-emitter voltage		V_{CES}	1200	V
Kollektor-Dauergleichstrom DC-collector current	$T_C = 80^\circ\text{C}$	$I_{C,nom.}$ I_C	40	A
	$T_C = 25^\circ\text{C}$		55	A
Periodischer Kollektor Spitzenstrom repetitive peak collector current	$t_p = 1\text{ ms}, T_C = 80^\circ\text{C}$	I_{CRM}	80	A
Gesamt-Verlustleistung total power dissipation	$T_C = 25^\circ\text{C}$	P_{tot}	200	W
Gate-Emitter-Spitzenspannung gate-emitter peak voltage		V_{GES}	+/- 20V	V

Diode Brems-Chopper/ Diode Brake-Chopper

Dauergleichstrom DC forward current	$T_C = 80^\circ\text{C}$	I_F	25	A
Periodischer Spitzenstrom repetitive peak forw. current	$t_p = 1\text{ ms}$	I_{FRM}	50	A

prepared by: Andreas Schulz	date of publication:06.03.2001
approved by: Hornkamp	revision: 1

Technische Information / Technical Information

IGBT-Module
IGBT-Modules

FP75R12KE3

eupec

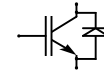

Vorläufige Daten Preliminary data

Modul Isolation/ Module Isolation

Isolations-Prüfspannung insulation test voltage	RMS, f = 50 Hz, t = 1 min. NTC connected to Baseplate	V _{ISOL}	2,5	kV
--	--	-------------------	-----	----

Elektrische Eigenschaften / Electrical properties

Charakteristische Werte / Characteristic values

Diode Gleichrichter/ Diode Rectifier

			min.	typ.	max.	
Durchlaßspannung forward voltage	T _{vj} = 150°C, I _F = 75 A	V _F	-	1,15	-	V
Schleusenspannung threshold voltage	T _{vj} = 150°C	V _(TO)	-	-	0,8	V
Ersatzwiderstand slope resistance	T _{vj} = 150°C	r _T	-	-	6,5	mΩ
Sperrstrom reverse current	T _{vj} = 150°C, V _R = 1600 V	I _R	-	3	-	mA
Modul Leitungswiderstand, Anschlüsse-Chip lead resistance, terminals-chip	T _C = 25°C	R _{AA'+CC'}	-	4	-	mΩ

Transistor Wechselrichter/ Transistor Inverter

			min.	typ.	max.	
Kollektor-Emitter Sättigungsspannung collector-emitter saturation voltage	V _{GE} = 15V, T _{vj} = 25°C, I _C = 75 A	V _{CE sat}	-	1,7	2,2	V
	V _{GE} = 15V, T _{vj} = 125°C, I _C = 75 A		-	2	-	V
Gate-Schwellenspannung gate threshold voltage	V _{CE} = V _{GE} , T _{vj} = 25°C, I _C = 3,0 mA	V _{GE(TO)}	5,0	5,8	6,5	V
Eingangskapazität input capacitance	f = 1MHz, T _{vj} = 25°C V _{CE} = 25 V, V _{GE} = 0 V	C _{ies}	-	5,3	-	nF
Kollektor-Emitter Reststrom collector-emitter cut off current	V _{GE} = 0V, T _{vj} = 25°C, V _{CE} = 1200 V	I _{CES}	-	-	5	mA
Gate-Emitter Reststrom gate-emitter leakage current	V _{CE} = 0V, V _{GE} = 20V, T _{vj} = 25°C	I _{GES}	-	-	400	nA
Einschaltverzögerungszeit (ind. Last) turn on delay time (inductive load)	I _C = I _{Nenn} , V _{CC} = 600 V	t _{d,on}	-	260	-	ns
	V _{GE} = ±15V, T _{vj} = 25°C, R _G = 5 Ohm					
	V _{GE} = ±15V, T _{vj} = 125°C, R _G = 5 Ohm					
Anstiegszeit (induktive Last) rise time (inductive load)	I _C = I _{Nenn} , V _{CC} = 600 V	t _r	-	30	-	ns
	V _{GE} = ±15V, T _{vj} = 25°C, R _G = 5 Ohm					
	V _{GE} = ±15V, T _{vj} = 125°C, R _G = 5 Ohm					
Abschaltverzögerungszeit (ind. Last) turn off delay time (inductive load)	I _C = I _{Nenn} , V _{CC} = 600 V	t _{d,off}	-	420	-	ns
	V _{GE} = ±15V, T _{vj} = 25°C, R _G = 5 Ohm					
	V _{GE} = ±15V, T _{vj} = 125°C, R _G = 5 Ohm					
Fallzeit (induktive Last) fall time (inductive load)	I _C = I _{Nenn} , V _{CC} = 600 V	t _f	-	65	-	ns
	V _{GE} = ±15V, T _{vj} = 25°C, R _G = 5 Ohm					
	V _{GE} = ±15V, T _{vj} = 125°C, R _G = 5 Ohm					
Einschaltverlustenergie pro Puls turn-on energy loss per pulse	I _C = I _{Nenn} , V _{CC} = 600 V V _{GE} = ±15V, T _{vj} = 125°C, R _G = 5 Ohm L _S = 45 nH	E _{on}	-	9,4	-	mWs
Abschaltverlustenergie pro Puls turn-off energy loss per pulse	I _C = I _{Nenn} , V _{CC} = 600 V V _{GE} = ±15V, T _{vj} = 125°C, R _G = 5 Ohm L _S = 45 nH	E _{off}	-	9,4	-	mWs
Kurzschlußverhalten SC Data	t _P ≤ 10µs, V _{GE} ≤ 15V, R _G = 5 Ohm T _{vj} ≤ 125°C, V _{CC} = 720 V	I _{SC}	-	300	-	A

Technische Information / Technical Information

IGBT-Module
IGBT-Modules

FP75R12KE3

eupec

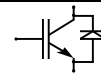

Vorläufige Daten Preliminary data

Elektrische Eigenschaften / Electrical properties

Charakteristische Werte / Characteristic values

		min.	typ.	max.		
Modulinduktivität stray inductance module		L_{GCE}	-	-	100	nH
Modul Leitungswiderstand, Anschlüsse-Chip lead resistance, terminals-chip	$T_C = 25^\circ\text{C}$	R_{CC+EE}	-	7	-	m Ω
Diode Wechselrichter/ Diode Inverter			min.	typ.	max.	
Durchlaßspannung forward voltage	$V_{GE} = 0\text{V}, T_{vj} = 25^\circ\text{C}, I_F = 75\text{A}$ $V_{GE} = 0\text{V}, T_{vj} = 125^\circ\text{C}, I_F = 75\text{A}$	V_F	-	1,65	2,2	V
Rückstromspitze peak reverse recovery current	$I_F = I_{Nenn}, -di_F/dt = 2000\text{A}/\mu\text{s}$ $V_{GE} = -10\text{V}, T_{vj} = 25^\circ\text{C}, V_R = 600\text{V}$ $V_{GE} = -10\text{V}, T_{vj} = 125^\circ\text{C}, V_R = 600\text{V}$	I_{RM}	-	80	-	A
Sperrverzögerungsladung recovered charge	$I_F = I_{Nenn}, -di_F/dt = 2000\text{A}/\mu\text{s}$ $V_{GE} = -10\text{V}, T_{vj} = 25^\circ\text{C}, V_R = 600\text{V}$ $V_{GE} = -10\text{V}, T_{vj} = 125^\circ\text{C}, V_R = 600\text{V}$	Q_f	-	9,3	-	μAs
Abschaltenergie pro Puls reverse recovery energy	$I_F = I_{Nenn}, -di_F/dt = 2000\text{A}/\mu\text{s}$ $V_{GE} = -10\text{V}, T_{vj} = 25^\circ\text{C}, V_R = 600\text{V}$ $V_{GE} = -10\text{V}, T_{vj} = 125^\circ\text{C}, V_R = 600\text{V}$	E_{RQ}	-	3,2	-	mWs
Transistor Brems-Chopper/ Transistor Brake-Chopper			min.	typ.	max.	
Kollektor-Emitter Sättigungsspannung collector-emitter saturation voltage	$V_{GE} = 15\text{V}, T_{vj} = 25^\circ\text{C}, I_C = 40\text{A}$ $V_{GE} = 15\text{V}, T_{vj} = 125^\circ\text{C}, I_C = 40\text{A}$	$V_{CE\text{ sat}}$	-	1,8	2,3	V
Gate-Schwellenspannung gate threshold voltage	$V_{CE} = V_{GE}, T_{vj} = 25^\circ\text{C}, I_C = 1,5\text{mA}$	$V_{GE(TO)}$	5,0	5,8	6,5	V
Eingangskapazität input capacitance	$f = 1\text{MHz}, T_{vj} = 25^\circ\text{C}$ $V_{CE} = 25\text{V}, V_{GE} = 0\text{V}$	C_{ies}	-	2,5	-	nF
Kollektor-Emitter Reststrom collector-emitter cut off current	$V_{GE} = 0\text{V}, T_{vj} = 25^\circ\text{C}, V_{CE} = 1200\text{V}$	I_{CES}	-	5,0	-	mA
Gate-Emitter Reststrom gate-emitter leakage current	$V_{CE} = 0\text{V}, V_{GE} = 20\text{V}, T_{vj} = 25^\circ\text{C}$	I_{GES}	-	-	400	nA
Schaltverluste und -bedingungen Switching losses and conditions	siehe Wechselrichter in Dbl FP40R12KE3 see inverter in datasheet FP40R12KE3					
Diode Brems-Chopper/ Diode Brake-Chopper			min.	typ.	max.	
Durchlaßspannung forward voltage	$T_{vj} = 25^\circ\text{C}, I_F = 40\text{A}$ $T_{vj} = 125^\circ\text{C}, I_F = 40\text{A}$	V_F	-	2,35	2,8	V
Schaltverluste und -bedingungen Switching losses and conditions	siehe Wechselrichter in Dbl FP25R12KE3 see inverter in datasheet FP25R12KE3					
NTC-Widerstand/ NTC-Thermistor			min.	typ.	max.	
Nennwiderstand rated resistance	$T_C = 25^\circ\text{C}$	R_{25}	-	5	-	k Ω
Abweichung von R_{100} deviation of R_{100}	$T_C = 100^\circ\text{C}, R_{100} = 493\ \Omega$	$\Delta R/R$	-5		5	%
Verlustleistung power dissipation	$T_C = 25^\circ\text{C}$	P_{25}			20	mW
B-Wert B-value	$R_2 = R_1 \exp [B(1/T_2 - 1/T_1)]$	$B_{25/50}$		3375		K

Technische Information / Technical Information

IGBT-Module
IGBT-Modules

FP75R12KE3

eupec

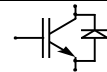

Vorläufige Daten Preliminary data

Thermische Eigenschaften / Thermal properties

				min.	typ.	max.	
Innerer Wärmewiderstand thermal resistance, junction to case	Gleichr. Diode/ Rectif. Diode	R_{thJC}	-	-	0,65	K/W	
	Trans. Wechr./ Trans. Inverter		-	-	0,35	K/W	
	Diode Wechr./ Diode Inverter		-	-	0,58	K/W	
	Trans. Bremse/ Trans. Brake		-	-	0,6	K/W	
	Diode Bremse/ Diode Brake		-	-	1,2	K/W	
Übergangs-Wärmewiderstand thermal resistance, case to heatsink	Gleichr. Diode/ Rectif. Diode	R_{thCK}	-	0,04	-	K/W	
	Trans. Wechr./ Trans. Inverter		-	0,02	-	K/W	
	Diode Wechr./ Diode Inverter		-	0,04	-	K/W	
Höchstzulässige Sperrschichttemperatur maximum junction temperature		T_{vj}	-	-	150	°C	
Betriebstemperatur operation temperature		T_{op}	-40	-	125	°C	
Lagertemperatur storage temperature		T_{stg}	-40	-	125	°C	

Mechanische Eigenschaften / Mechanical properties

Innere Isolation internal insulation				Al_2O_3	
CTI comperative tracking index				225	
Anzugsdrehmoment f. mech. Befestigung mounting torque		M		3 ±10%	Nm
Gewicht weight		G		300	g

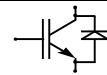

Vorläufige Daten
Preliminary data

Ausgangskennlinienfeld Wechselr. (typisch) $I_C = f(V_{CE})$
Output characteristic Inverter (typical) $V_{GE} = 15\text{ V}$

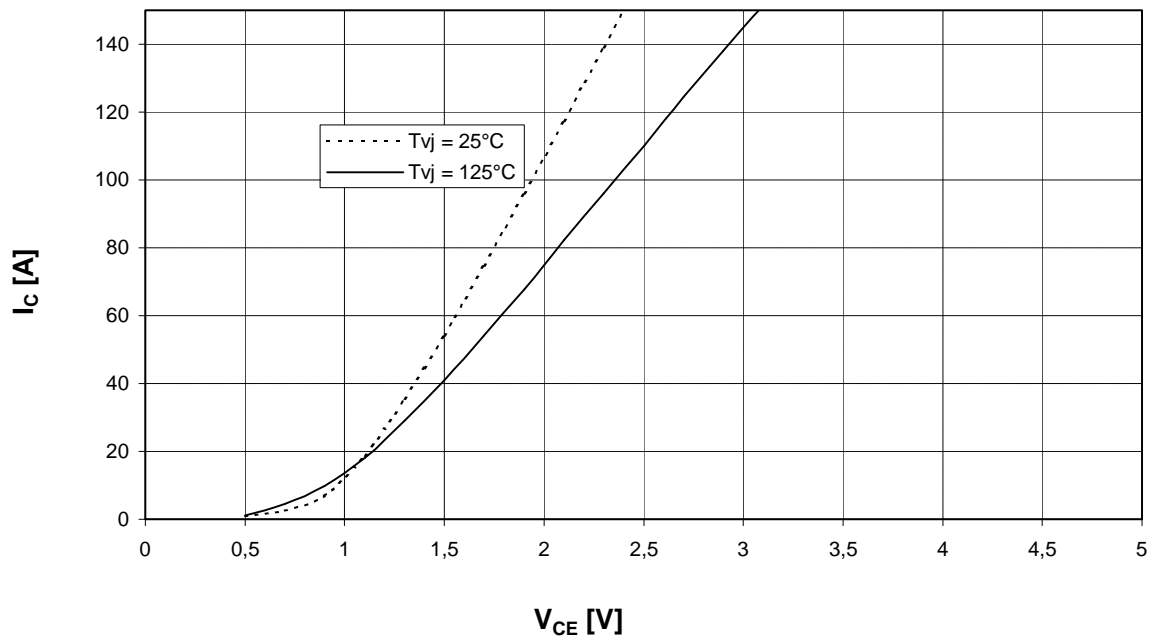

Ausgangskennlinienfeld Wechselr. (typisch) $I_C = f(V_{CE})$
Output characteristic Inverter (typical) $T_{vj} = 125^\circ\text{C}$

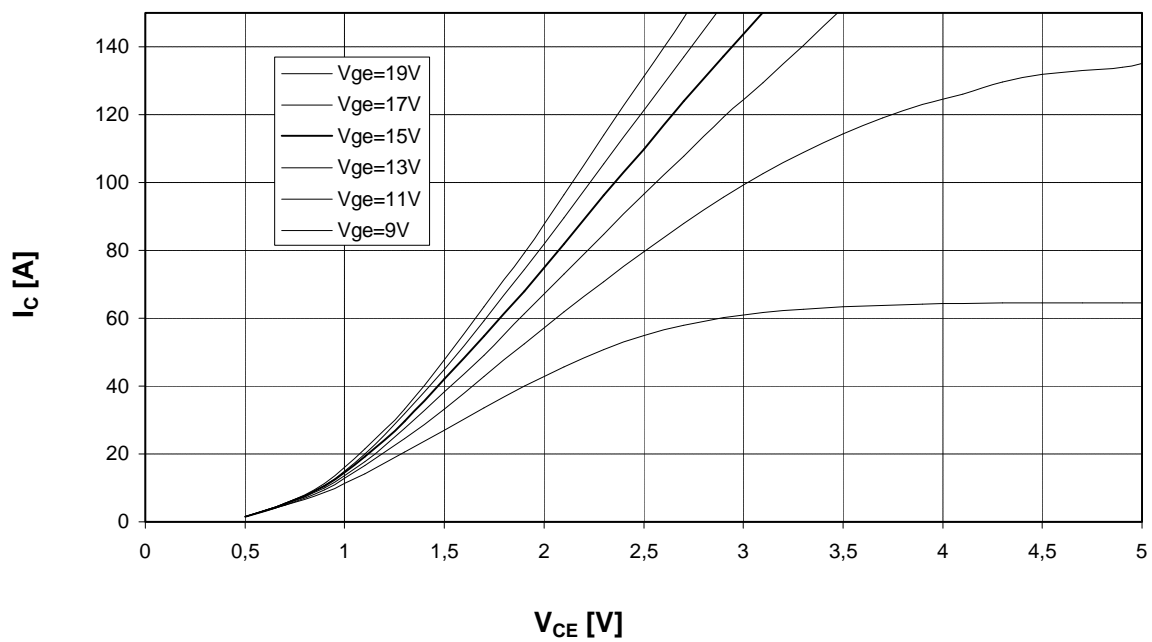

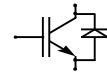

Vorläufige Daten
Preliminary data

Übertragungscharakteristik Wechselr. (typisch)
Transfer characteristic Inverter (typical)

$I_C = f(V_{GE})$
 $V_{CE} = 20\text{ V}$

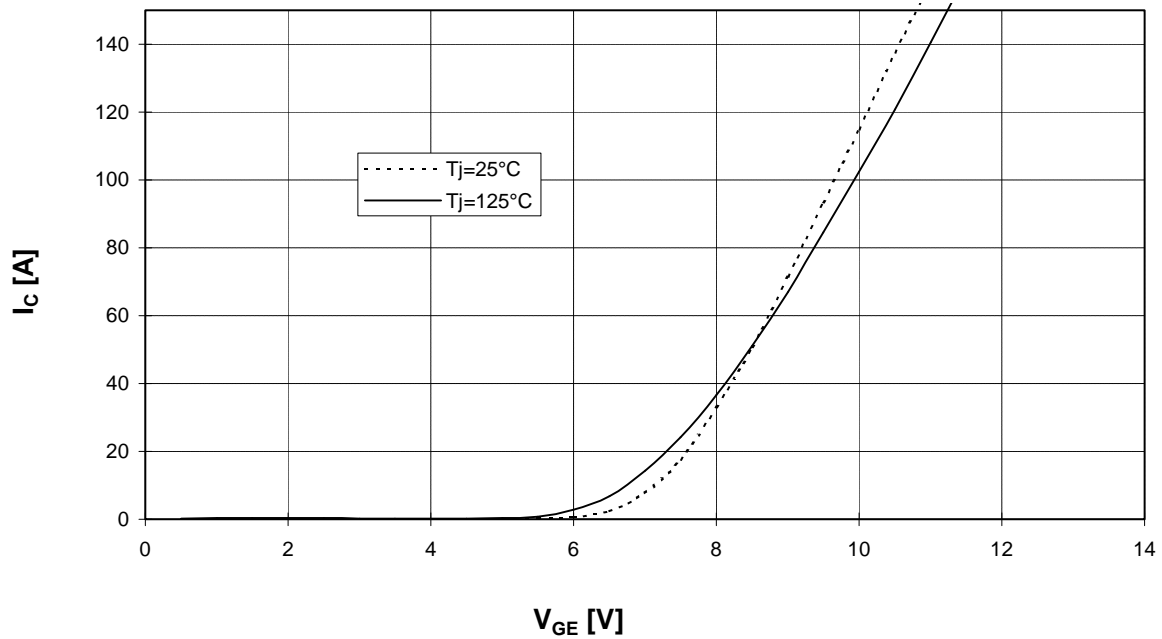

Durchlaßkennlinie der Freilaufdiode Wechselr. (typisch)
Forward characteristic of FWD Inverter (typical)

$I_F = f(V_F)$

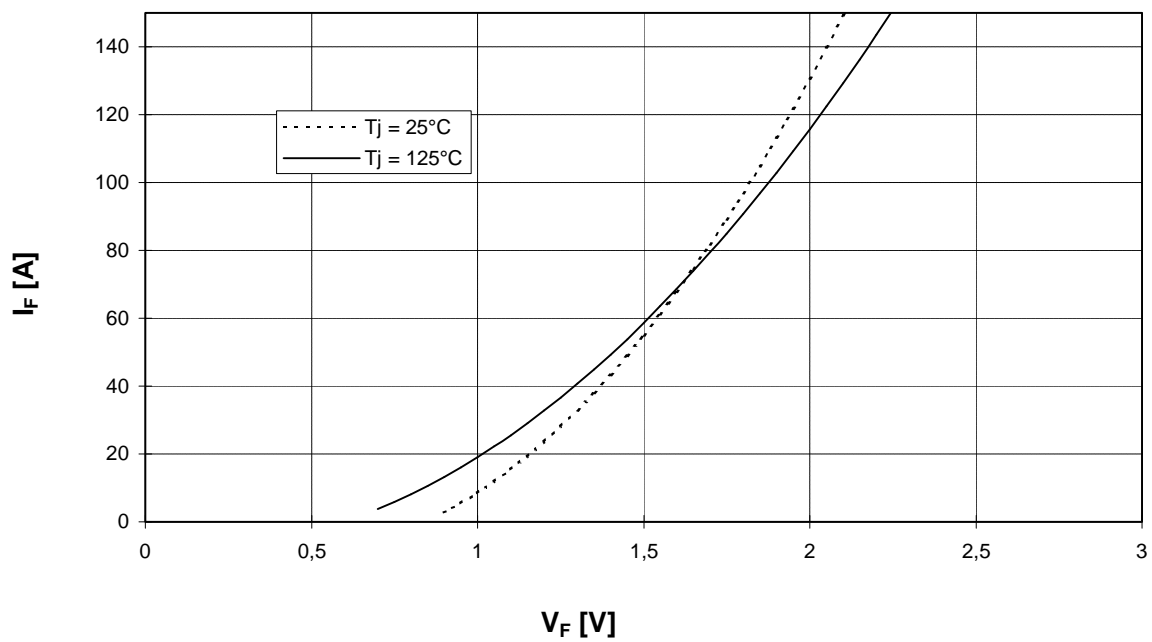

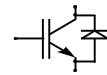

Vorläufige Daten
Preliminary data

Schaltverluste Wechselr. (typisch) $E_{on} = f(I_C), E_{off} = f(I_C), E_{rec} = f(I_C)$ $V_{CC} = 600\text{ V}$
 Switching losses Inverter (typical) $T_j = 125^\circ\text{C}, V_{GE} = \pm 15\text{ V}, R_{Gon} = R_{Goff} = 4,7\text{ Ohm}$

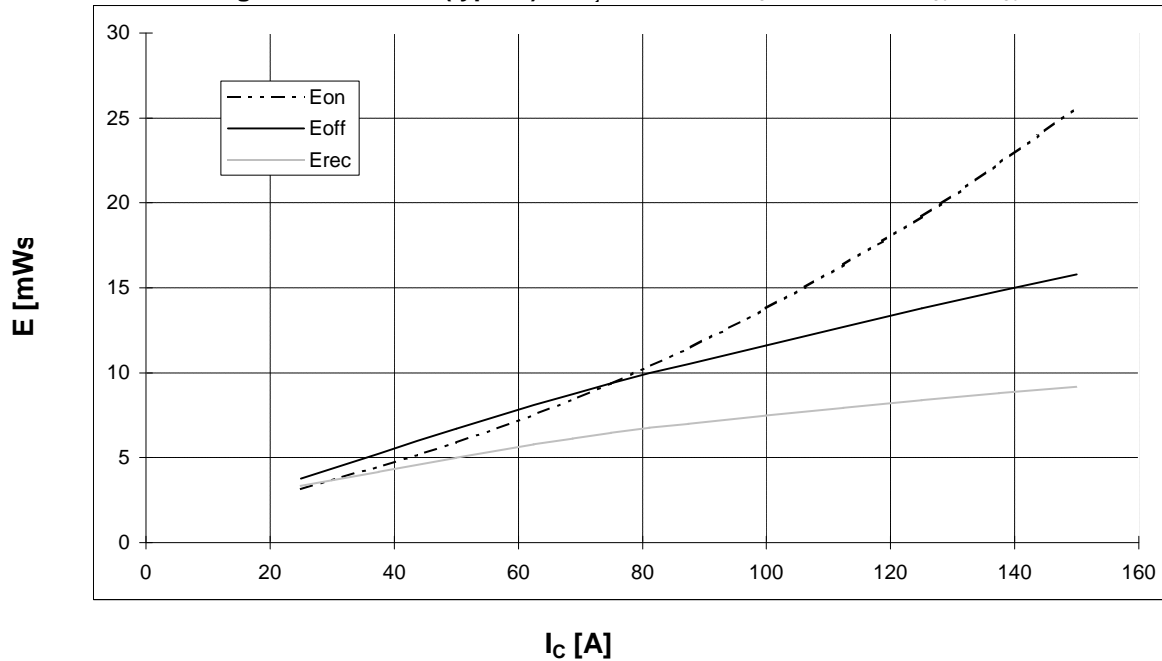

Schaltverluste Wechselr. (typisch) $E_{on} = f(R_G), E_{off} = f(R_G), E_{rec} = f(R_G)$ $V_{CC} = 600\text{ V}$
 Switching losses Inverter (typical) $T_j = 125^\circ\text{C}, V_{GE} = \pm 15\text{ V}, I_C = I_{nenn}, V_{CC} = 600\text{ V}$

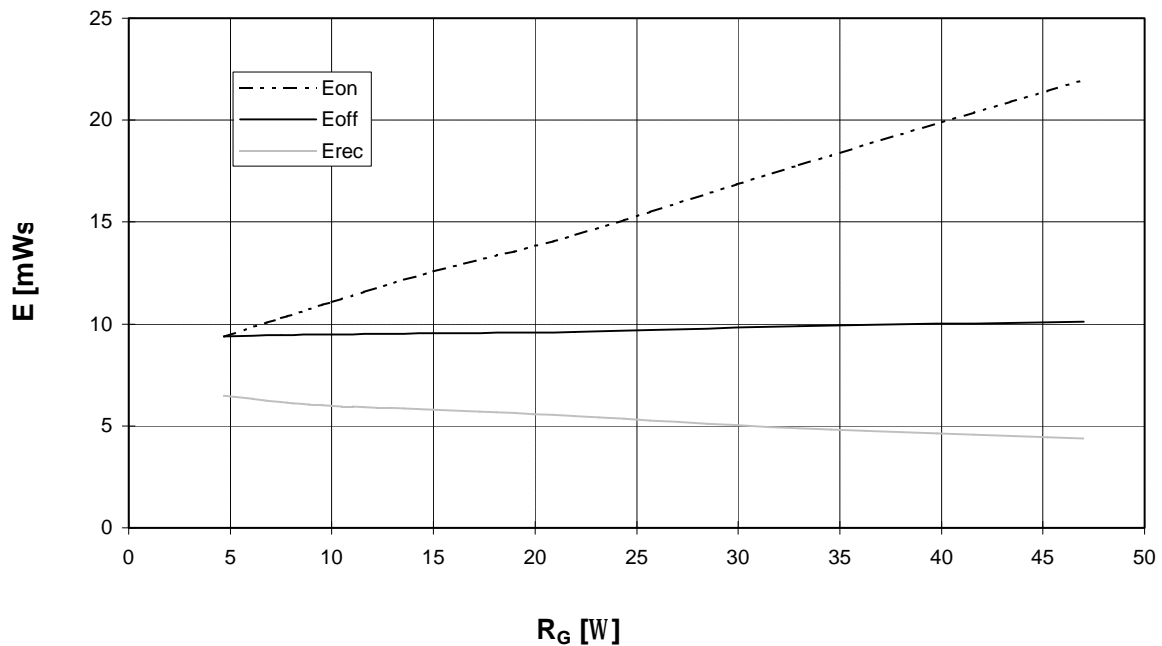

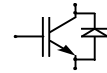

Vorläufige Daten
Preliminary data

Transienter Wärmewiderstand Wechslr. $Z_{thJC} = f(t)$
Transient thermal impedance Inverter

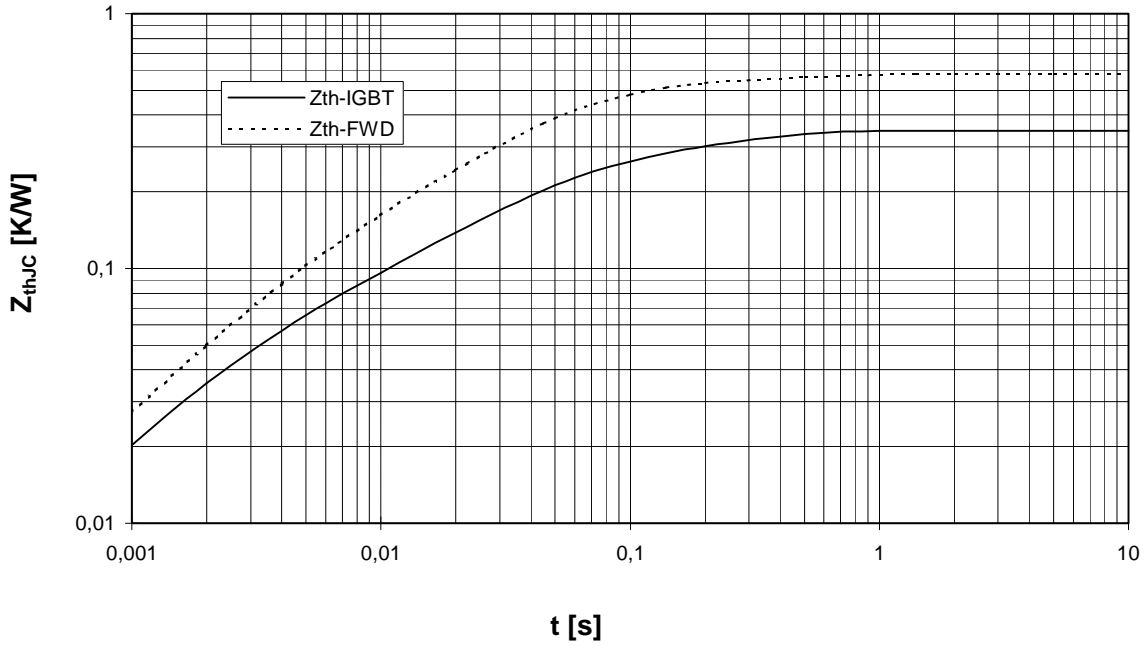

Sicherer Arbeitsbereich Wechslr. (RBSOA) $I_C = f(V_{CE})$
Reverse bias safe operating area Inverter (RBSOA) $T_{vi} = 125^\circ\text{C}, V_{GE} = \pm 15\text{V}, R_G = 4,7 \text{ Ohm}$

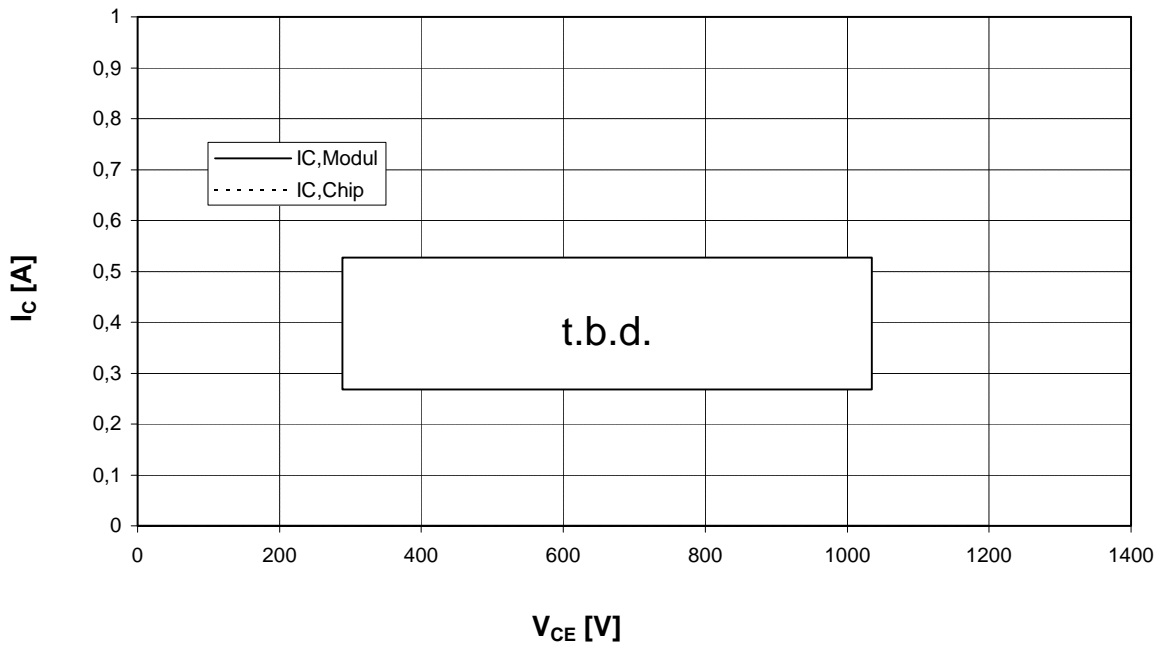

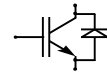

Vorläufige Daten
Preliminary data

Ausgangskennlinienfeld Brems-Chopper-IGBT (typisch)
Output characteristic brake-chopper-IGBT (typical)

$I_C = f(V_{CE})$
 $V_{GE} = 15\text{ V}$

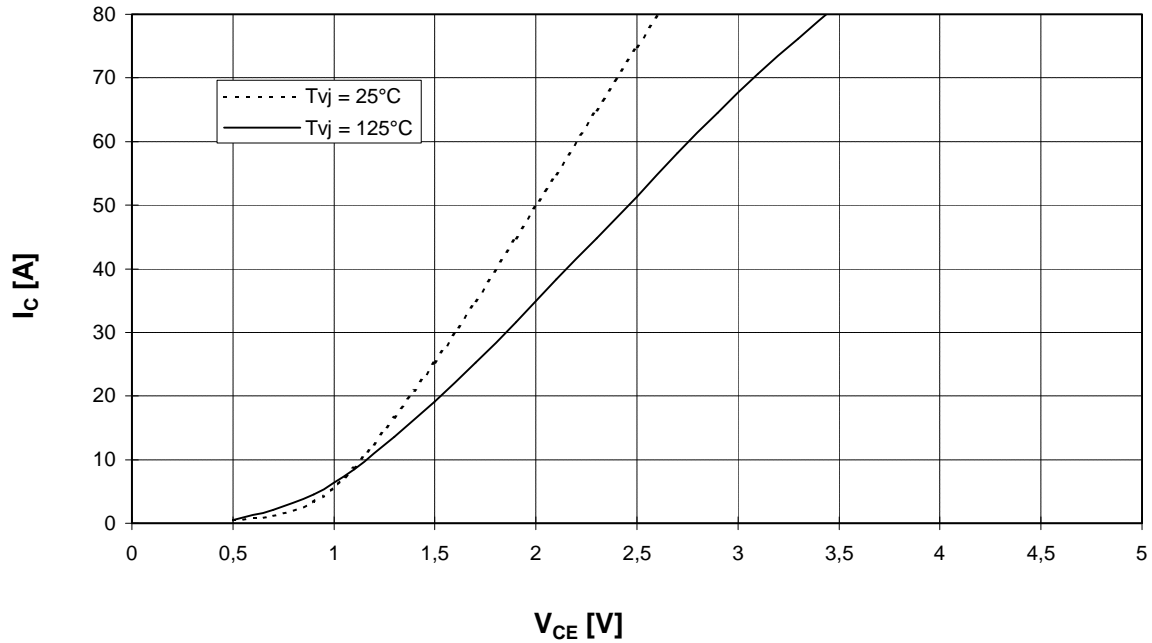

Durchlaßkennlinie der Brems-Chopper-Diode (typisch) $I_F = f(V_F)$
Forward characteristic of brake-chopper-FWD (typical)

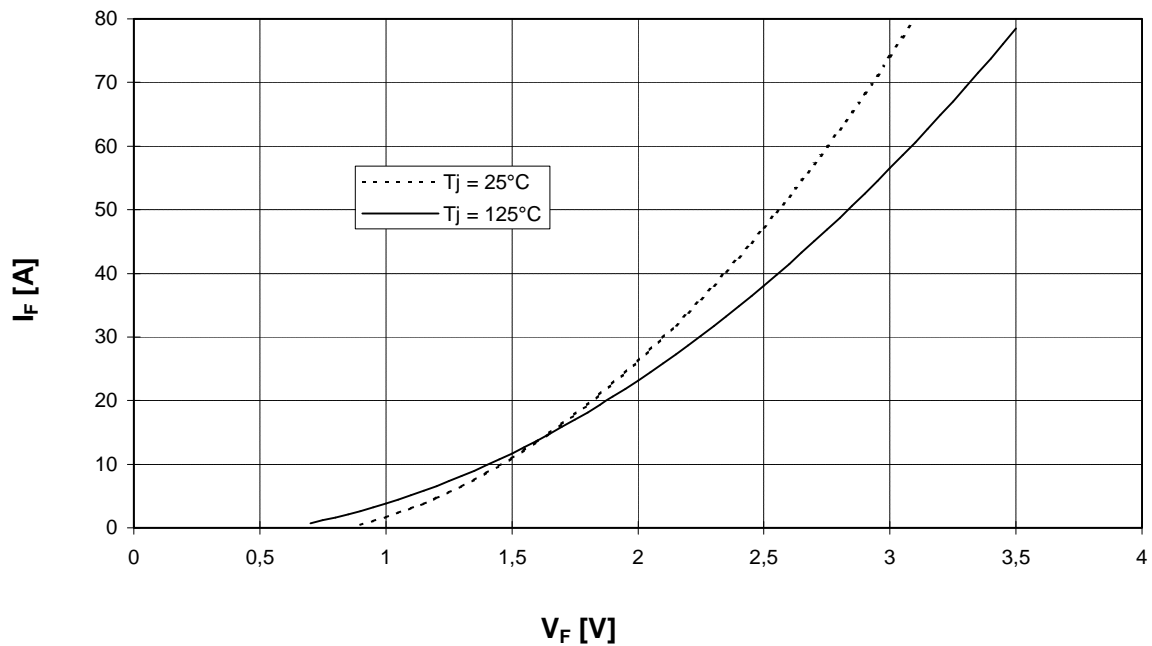

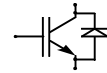

Vorläufige Daten
Preliminary data

Durchlaßkennlinie der Gleichrichterdiode (typisch) $I_F = f(V_F)$
Forward characteristic of Rectifier Diode (typical)

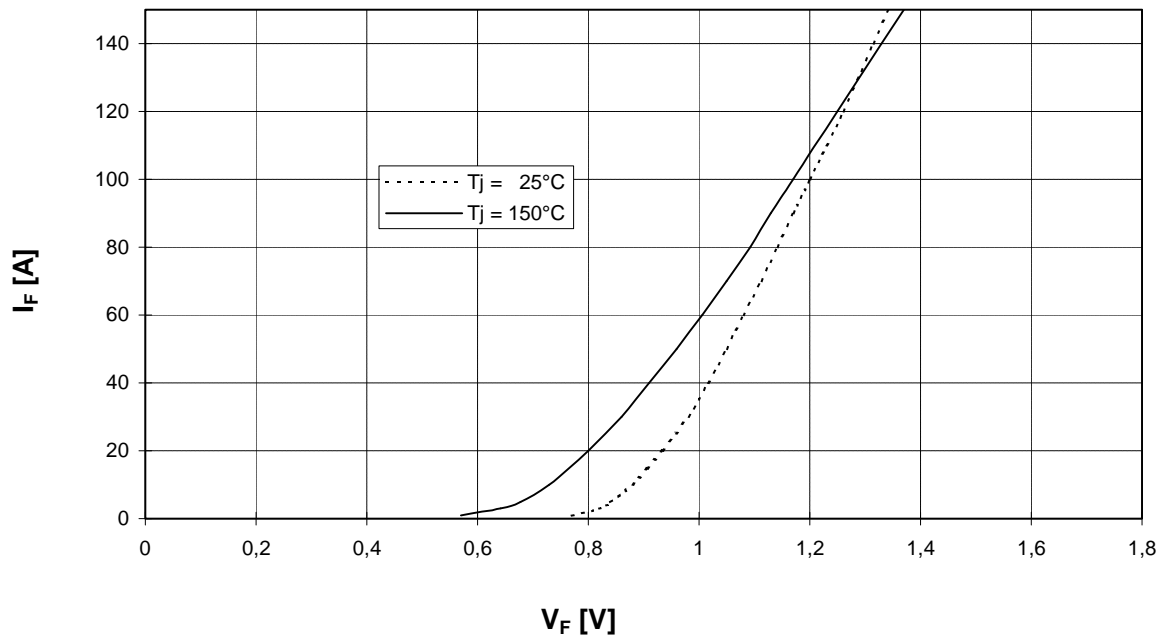

NTC- Temperaturkennlinie (typisch) $R = f(T)$
NTC- temperature characteristic (typical)

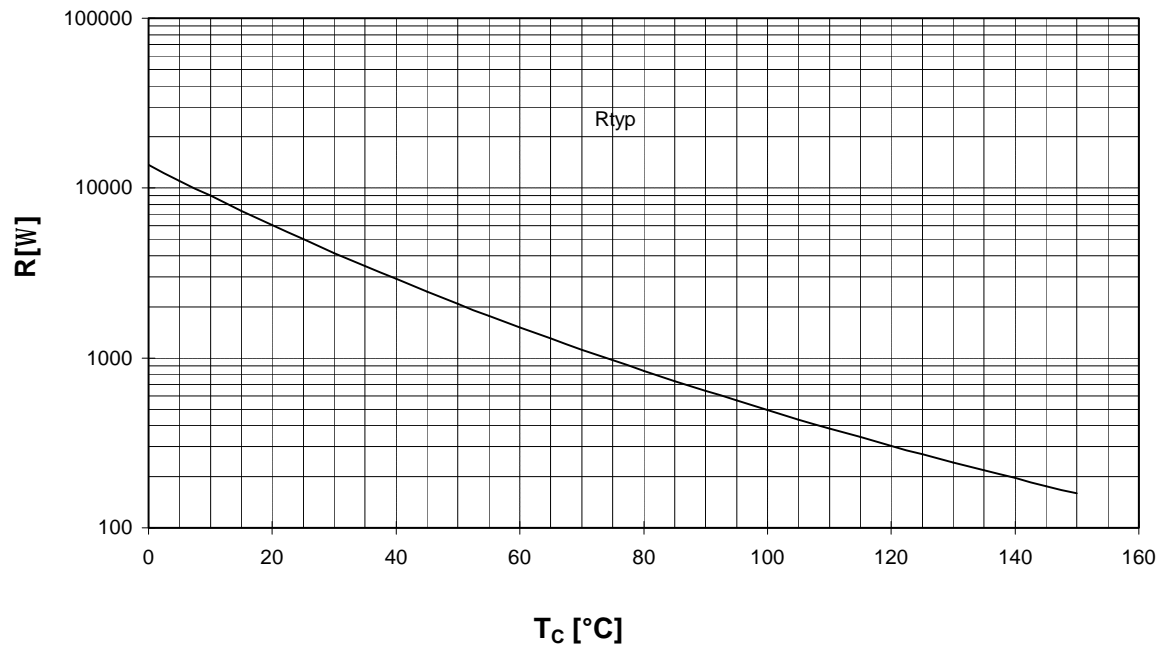

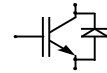

Vorläufige Daten
Preliminary data

Schaltplan/ Circuit diagram

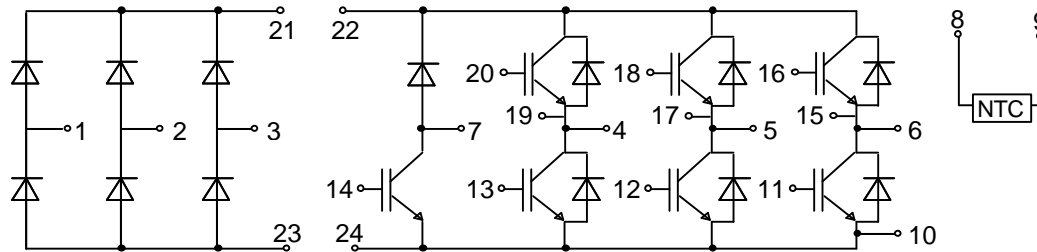

Gehäuseabmessungen/ Package outlines

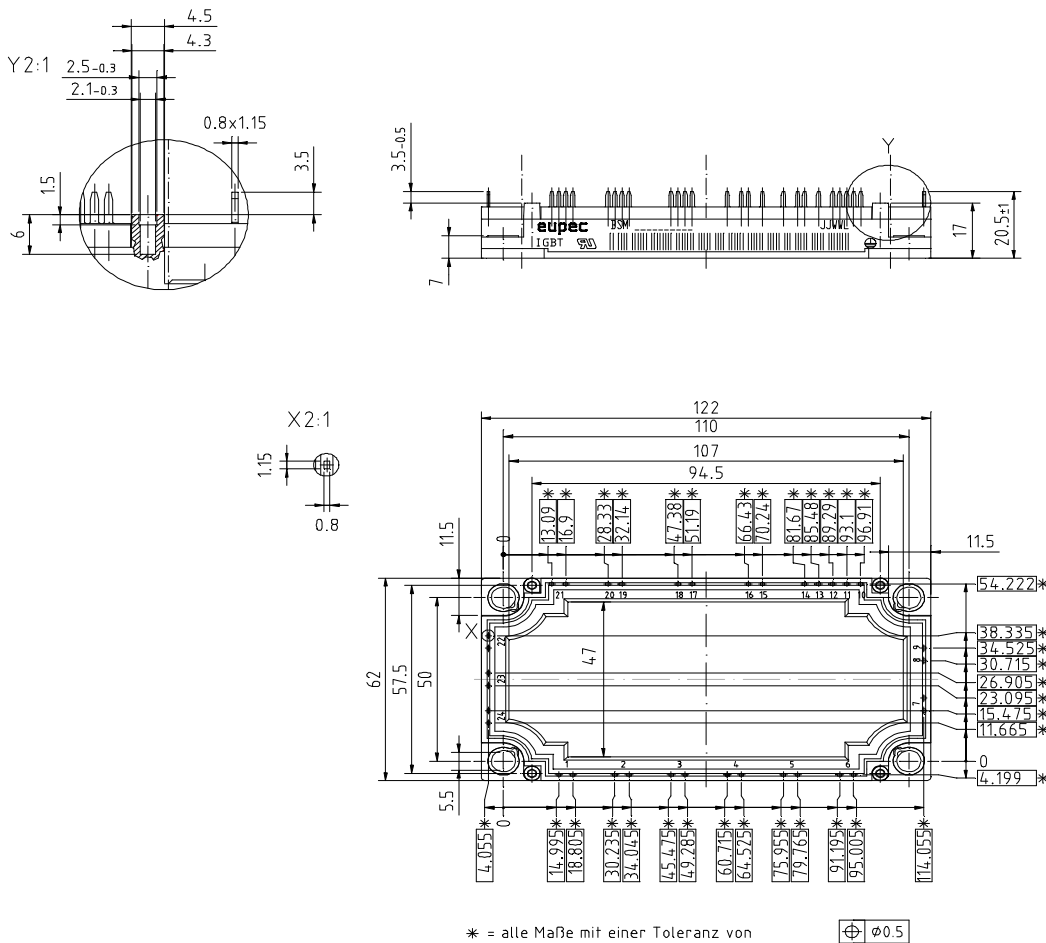

Mit dieser technischen Information werden Halbleiterbauelemente spezifiziert, jedoch keine Eigenschaften zugesichert. Sie gilt in Verbindung mit den zugehörigen Technischen Erläuterungen.

This technical information specifies semiconductor devices but promises no characteristics. It is valid in combination with the belonging technical notes.