

# MITSUBISHI IGBT MODULES

## CM300DY-28H

HIGH POWER SWITCHING USE  
INSULATED TYPE

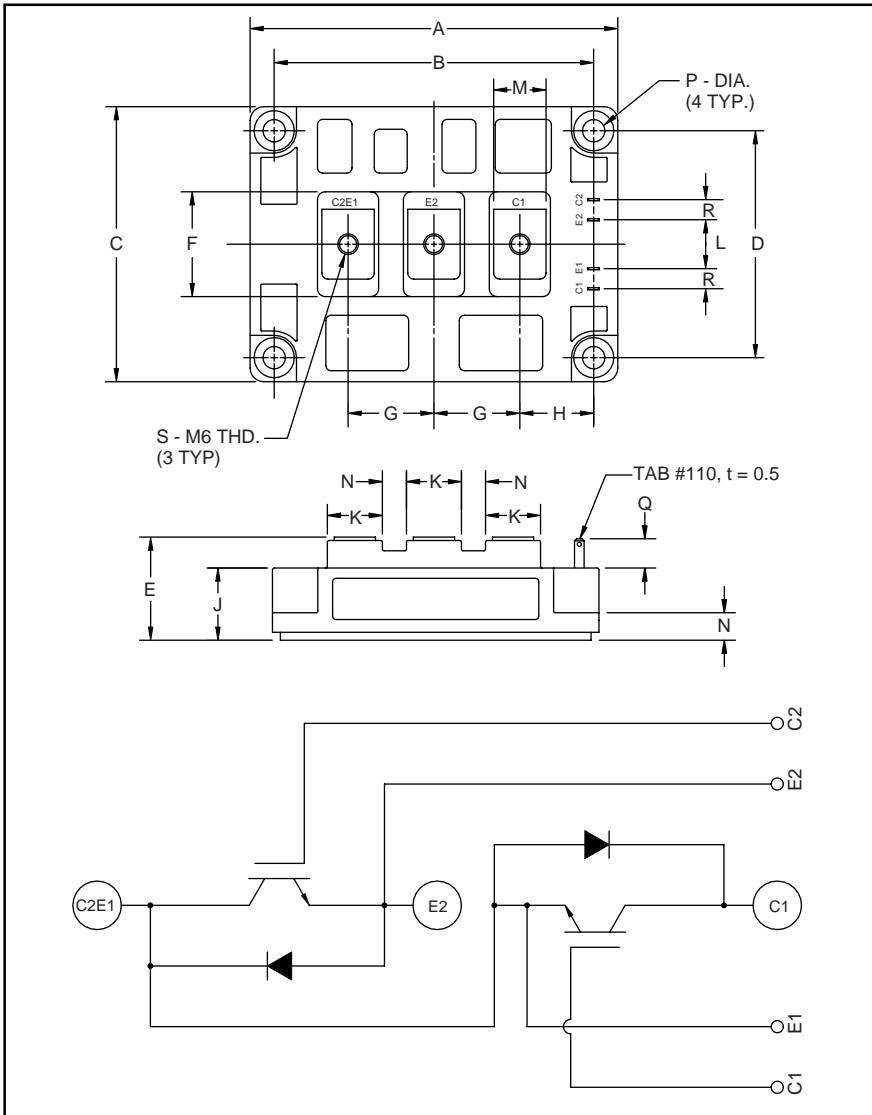

Outline Drawing and Circuit Diagram

Dimensions	Inches	Millimeters
A	4.33	110.0
B	3.661±0.01	93.0±0.25
C	3.15	80.0
D	2.441±0.01	62.0±0.25
E	1.18 Max.	30.0 Max.
F	1.18	30.0
G	0.98	25.0
H	0.85	21.5
J	0.83	21.2

Dimensions	Inches	Millimeters
K	0.71	18.0
L	0.59	15.0
M	0.55	14.0
N	0.28	7.0
P	0.26 Dia.	Dia. 6.5
Q	0.33	8.5
R	0.24	6.0
S	M6 Metric	M6



### Description:

Mitsubishi IGBT Modules are designed for use in switching applications. Each module consists of two IGBTs in a half-bridge configuration with each transistor having a reverse-connected super-fast recovery free-wheel diode. All components and interconnects are isolated from the heat sinking baseplate, offering simplified system assembly and thermal management.

### Features:

- Low Drive Power
- Low  $V_{CE(sat)}$
- Discrete Super-Fast Recovery Free-Wheel Diode
- High Frequency Operation
- Isolated Baseplate for Easy Heat Sinking

### Applications:

- AC Motor Control
- Motion/Servo Control
- UPS
- Welding Power Supplies

### Ordering Information:

Example: Select the complete part module number you desire from the table below -i.e. CM300DY-28H is a 1400V ( $V_{CES}$ ), 300 Ampere Dual IGBT Module.

Type	Current Rating Amperes	$V_{CES}$ Volts (x 50)
CM	300	28

## CM300DY-28H

HIGH POWER SWITCHING USE  
INSULATED TYPEAbsolute Maximum Ratings,  $T_j = 25\text{ }^\circ\text{C}$  unless otherwise specified

Ratings	Symbol	CM300DY-28H	Units
Junction Temperature	$T_j$	-40 to 150	$^\circ\text{C}$
Storage Temperature	$T_{stg}$	-40 to 125	$^\circ\text{C}$
Collector-Emitter Voltage (G-E SHORT)	$V_{CES}$	1400	Volts
Gate-Emitter Voltage (C-E SHORT)	$V_{GES}$	$\pm 20$	Volts
Collector Current ( $T_C = 25\text{ }^\circ\text{C}$ )	$I_C$	300	Amperes
Peak Collector Current	$I_{CM}$	600*	Amperes
Emitter Current** ( $T_C = 25\text{ }^\circ\text{C}$ )	$I_E$	300	Amperes
Peak Emitter Current**	$I_{EM}$	600*	Amperes
Maximum Collector Dissipation ( $T_C = 25\text{ }^\circ\text{C}$ , $T_j \leq 150\text{ }^\circ\text{C}$ )	$P_c$	2100	Watts
Mounting Torque, M6 Main Terminal	-	1.96 ~ 2.94	N · m
Mounting Torque, M6 Mounting	-	1.96 ~ 2.94	N · m
Weight	-	500	Grams
Isolation Voltage (Main Terminal to Baseplate, AC 1 min.)	$V_{iso}$	2500	Vrms

\*Pulse width and repetition rate should be such that the device junction temperature ( $T_j$ ) does not exceed  $T_{j(max)}$  rating.

\*\*Represents characteristics of the anti-parallel, emitter-to-collector free-wheel diode (FWDi).

Static Electrical Characteristics,  $T_j = 25\text{ }^\circ\text{C}$  unless otherwise specified

Characteristics	Symbol	Test Conditions	Min.	Typ.	Max.	Units
Collector-Cutoff Current	$I_{CES}$	$V_{CE} = V_{CES}$ , $V_{GE} = 0V$	-	-	1.0	mA
Gate Leakage Current	$I_{GES}$	$V_{GE} = V_{GES}$ , $V_{CE} = 0V$	-	-	0.5	$\mu\text{A}$
Gate-Emitter Threshold Voltage	$V_{GE(th)}$	$I_C = 30\text{mA}$ , $V_{CE} = 10V$	5.0	6.5	8.0	Volts
Collector-Emitter Saturation Voltage	$V_{CE(sat)}$	$I_C = 300\text{A}$ , $V_{GE} = 15V$	-	3.1	4.2**	Volts
		$I_C = 300\text{A}$ , $V_{GE} = 15V$ , $T_j = 150\text{ }^\circ\text{C}$	-	2.95	-	Volts
Total Gate Charge	$Q_G$	$V_{CC} = 800V$ , $I_C = 300\text{A}$ , $V_{GE} = 15V$	-	1530	-	nC
Emitter-Collector Voltage	$V_{EC}$	$I_E = 300\text{A}$ , $V_{GE} = 0V$	-	-	3.8	Volts

\*\* Pulse width and repetition rate should be such that device junction temperature rise is negligible.

Dynamic Electrical Characteristics,  $T_j = 25\text{ }^\circ\text{C}$  unless otherwise specified

Characteristics	Symbol	Test Conditions	Min.	Typ.	Max.	Units	
Input Capacitance	$C_{ies}$		-	-	60	nF	
Output Capacitance	$C_{oes}$	$V_{GE} = 0V$ , $V_{CE} = 10V$	-	-	21	nF	
Reverse Transfer Capacitance	$C_{res}$		-	-	12	nF	
Resistive	Turn-on Delay Time	$V_{CC} = 800V$ , $I_C = 300\text{A}$ , $V_{GE1} = V_{GE2} = 15V$ , $R_G = 1.0\Omega$	-	-	250	ns	
Load	Rise Time		$t_r$	-	-	500	ns
Switching	Turn-off Delay Time		$t_{d(off)}$	-	-	350	ns
Times	Fall Time		$t_f$	-	-	500	ns
Diode Reverse Recovery Time	$t_{rr}$	$I_E = 300\text{A}$ , $di_E/dt = -600\text{A}/\mu\text{s}$	-	-	300	ns	
Diode Reverse Recovery Charge	$Q_{rr}$	$I_E = 300\text{A}$ , $di_E/dt = -600\text{A}/\mu\text{s}$	-	3.0	-	$\mu\text{C}$	

Thermal and Mechanical Characteristics,  $T_j = 25\text{ }^\circ\text{C}$  unless otherwise specified

Characteristics	Symbol	Test Conditions	Min.	Typ.	Max.	Units
Thermal Resistance, Junction to Case	$R_{th(j-c)}$	Per IGBT	-	-	0.06	$^\circ\text{C}/\text{W}$
Thermal Resistance, Junction to Case	$R_{th(j-c)}$	Per FWDi	-	-	0.12	$^\circ\text{C}/\text{W}$
Contact Thermal Resistance	$R_{th(c-f)}$	Per Module, Thermal Grease Applied	-	-	0.035	$^\circ\text{C}/\text{W}$

# CM300DY-28H

HIGH POWER SWITCHING USE  
INSULATED TYPE

OUTPUT CHARACTERISTICS  
(TYPICAL)

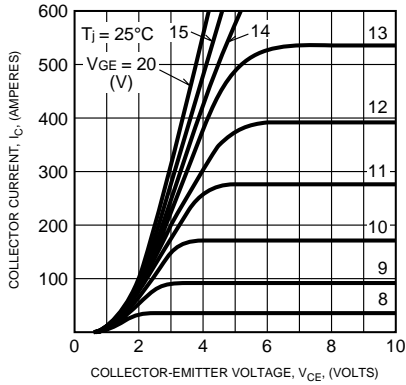

TRANSFER CHARACTERISTICS  
(TYPICAL)

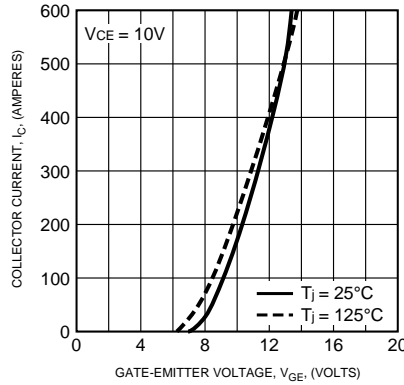

COLLECTOR-EMITTER SATURATION VOLTAGE CHARACTERISTICS  
(TYPICAL)

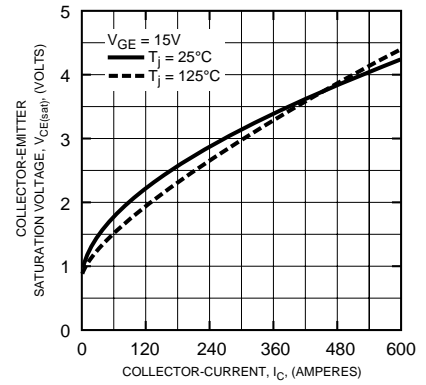

COLLECTOR-EMITTER SATURATION VOLTAGE CHARACTERISTICS  
(TYPICAL)

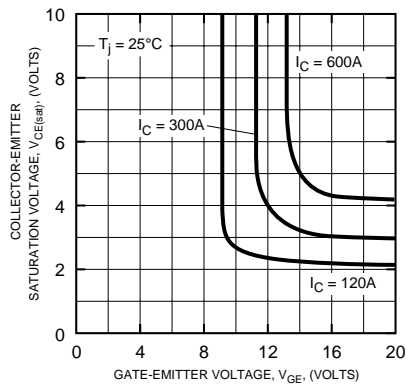

FREE-WHEEL DIODE FORWARD CHARACTERISTICS  
(TYPICAL)

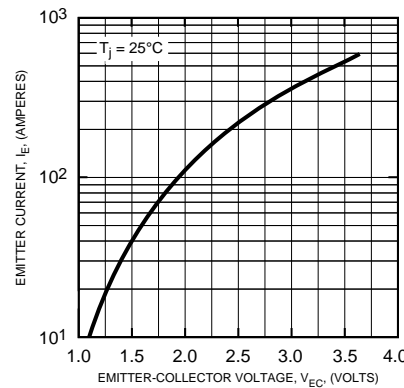

CAPACITANCE VS.  $V_{CE}$   
(TYPICAL)

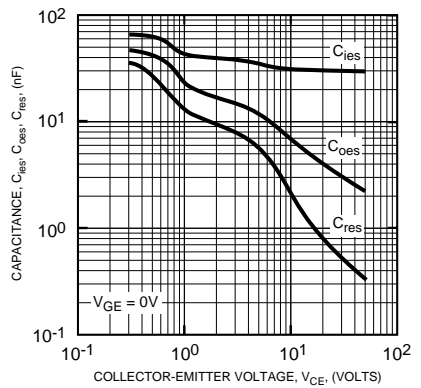

HALF-BRIDGE SWITCHING CHARACTERISTICS  
(TYPICAL)

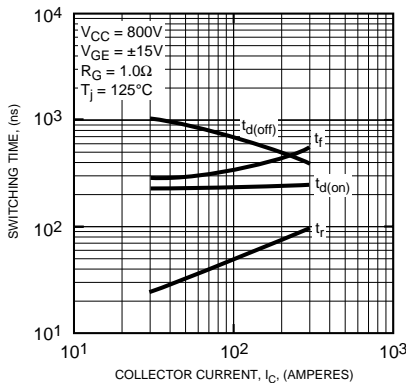

REVERSE RECOVERY CHARACTERISTICS  
(TYPICAL)

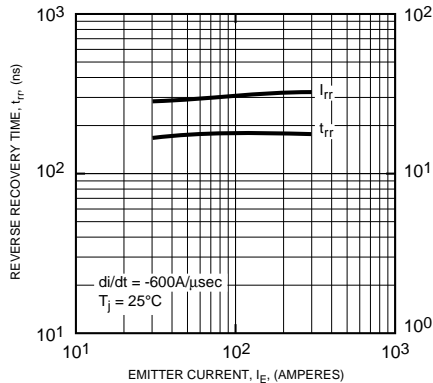

GATE CHARGE,  $V_{GE}$

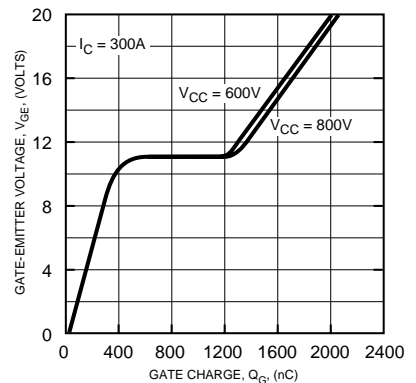

# CM300DY-28H

HIGH POWER SWITCHING USE  
INSULATED TYPE

