

Typical Applications

The HMC595 / HMC595E is ideal for:

- Cellular/3G Infrastructure
- Private Mobile Radio Handsets
- WLAN, WiMAX & WiBro
- Automotive Telematics
- Test Equipment

Features

- Low Insertion Loss: 0.3 dB
- High Input IP3: +65 dBm
- Isolation: 30 dB
- Positive Control: 0/+3V to 0/+10V
- Ultra Small Package: SOT26
- Included in the HMC-DK005 Designer's Kit

Functional Diagram

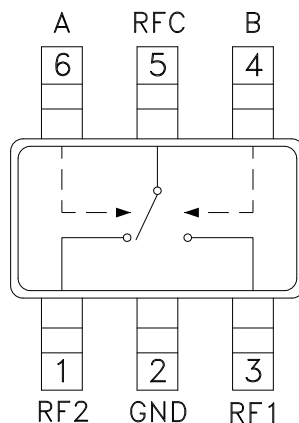

General Description

The HMC595 & HMC595E are low-cost SPDT switches in 6-lead SOT26 packages for use in transmit/receive applications which require very low distortion at high incident power levels. The device can control signals from DC to 3 GHz and is especially suited for Cellular/3G infrastructure, WiMAX and WiBro applications with only 0.3 dB typical insertion loss. The design provides a 3 watt power handling and +65 dBm third order intercept at +8 Volt bias. RF1 and RF2 are reflective shorts when "Off". Control inputs A & B are compatible with CMOS and some TTL logic families. These products are form, fit and function replacements for HMC195 & HMC195E while offering superior electrical performance.

Electrical Specifications,

$T_A = +25^\circ \text{C}$, $V_{ctl} = 0/+5 \text{Vdc}$ (Unless Otherwise Stated), 50 Ohm System

Parameter	Frequency	Min.	Typ.	Max.	Units
Insertion Loss	DC - 1.0 GHz		0.25	0.5	dB
	DC - 2.0 GHz		0.3	0.6	dB
	DC - 2.5 GHz		0.4	0.7	dB
	DC - 3.0 GHz		0.5	0.8	dB
Isolation	DC - 1.0 GHz	26	30		dB
	DC - 2.0 GHz	22	26		dB
	DC - 2.5 GHz	18	24		dB
	DC - 3.0 GHz	14	18		dB
Return Loss	DC - 1.0 GHz		30		dB
	DC - 2.0 GHz		25		dB
	DC - 2.5 GHz		22		dB
	DC - 3.0 GHz		20		dB
Input Power for 1dB Compression	0.5 - 3.0 GHz	$V_{ctl} = 0/+3V$	32	35	dBm
		$V_{ctl} = 0/+5V$	35	38	dBm
		$V_{ctl} = 0/+8V$	37	39	dBm
Input Third Order Intercept (Two-tone Input Power = +27 dBm Each Tone)	0.5 - 3.0 GHz	$V_{ctl} = 0/+3V$		47	dBm
		$V_{ctl} = 0/+5V$		64	dBm
		$V_{ctl} = 0/+8V$		65	dBm
Switching Characteristics	DC - 3.0 GHz	t_{RISE}, t_{FALL} (10/90% RF)	80		ns
		t_{ON}, t_{OFF} (50% CTL to 10/90% RF)	120		ns

For price, delivery, and to place orders, please contact Hittite Microwave Corporation:
20 Alpha Road, Chelmsford, MA 01824 Phone: 978-250-3343 Fax: 978-250-3373
Order On-line at www.hittite.com



Insertion Loss

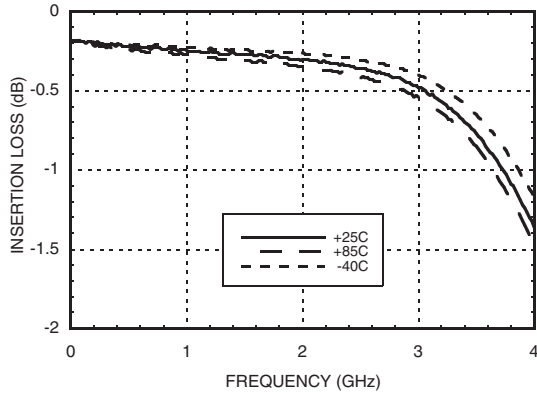

Isolation Between RFC and RF1/RF2

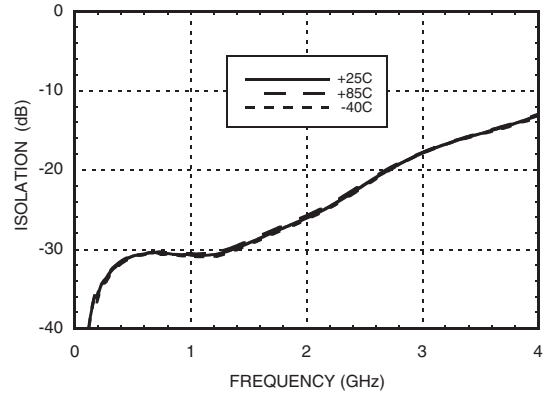

RF1 to RF2 Isolations

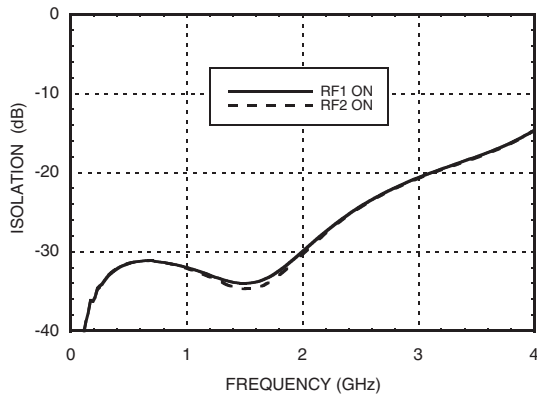

Return Loss

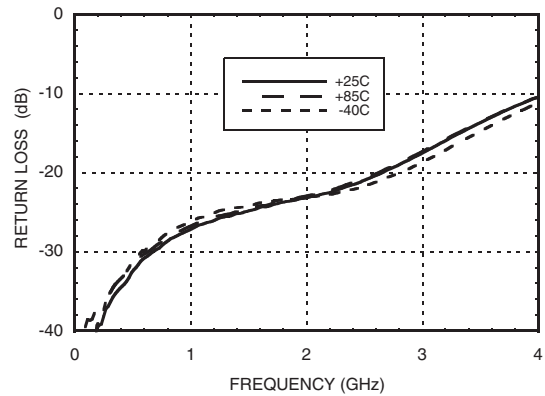

Input P0.1dB vs. Vctl

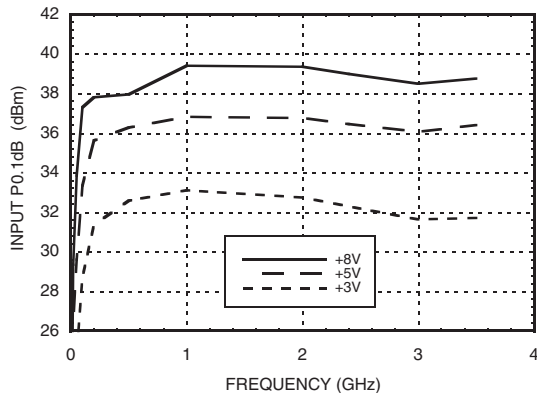

Input P1dB vs. Vctl

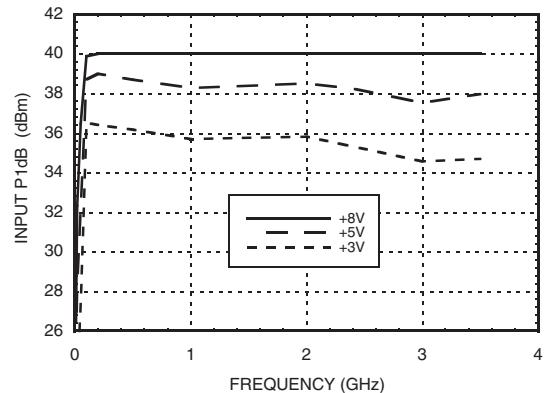



GaAs MMIC 3 WATT T/R SWITCH, DC - 3 GHz

Input IP3 vs. Input Power @ 900 MHz

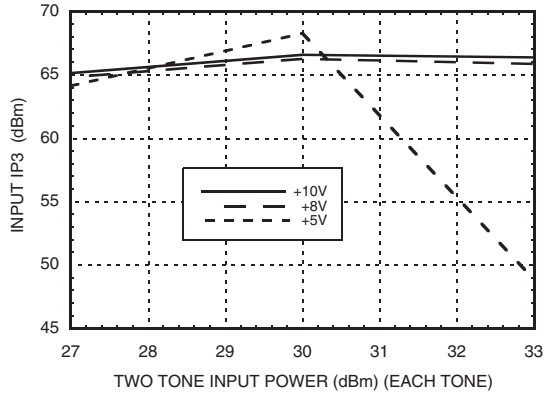

Input IP3 vs. Input Power @ 1900 MHz

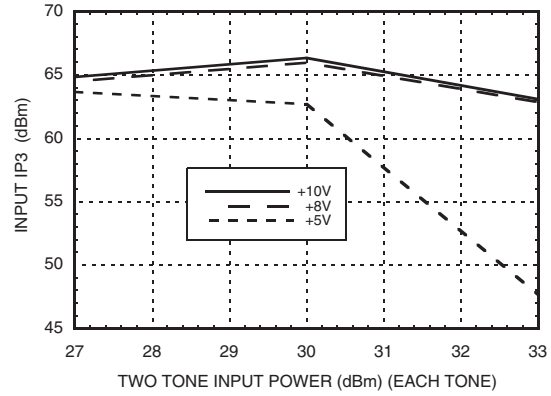

Input Third Order Intercept Point

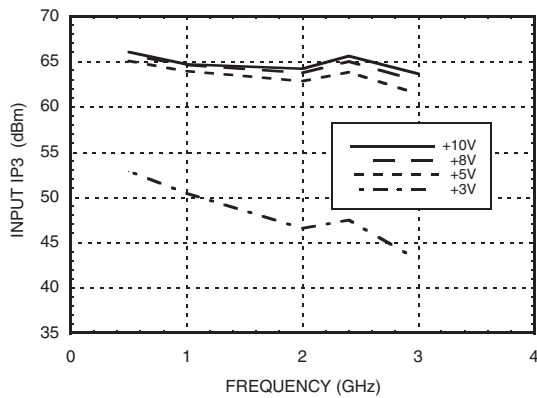

**2nd & 3rd Harmonics @ 900 MHz
Vctl = +3 Volts**

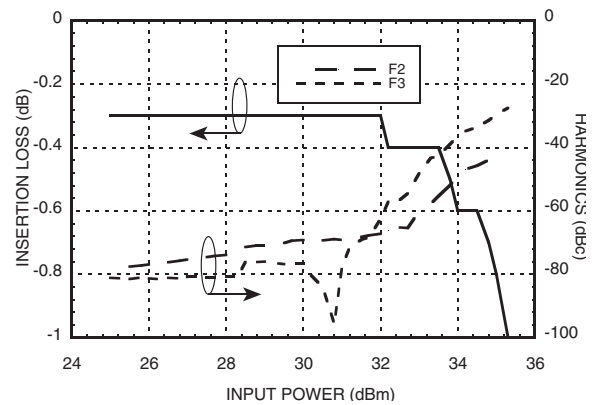

**2nd & 3rd Harmonics @ 900 MHz
Vctl = +5 Volts**

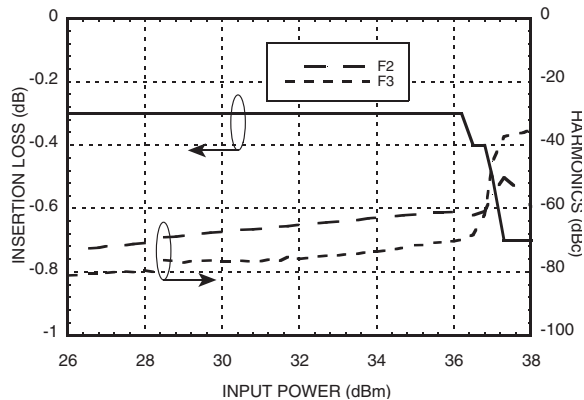

**2nd & 3rd Harmonics @ 900 MHz
Vctl = +8 Volts**

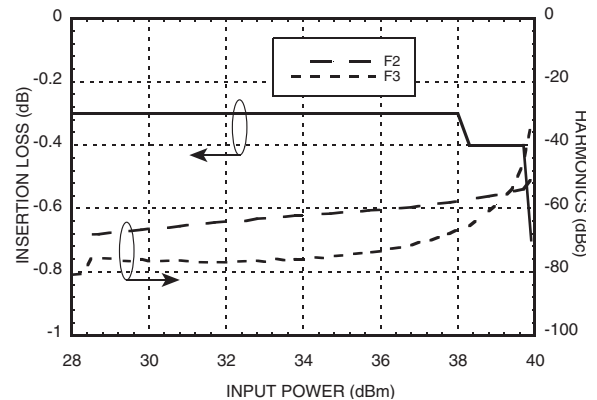



Input P0.1dB vs. Vctl

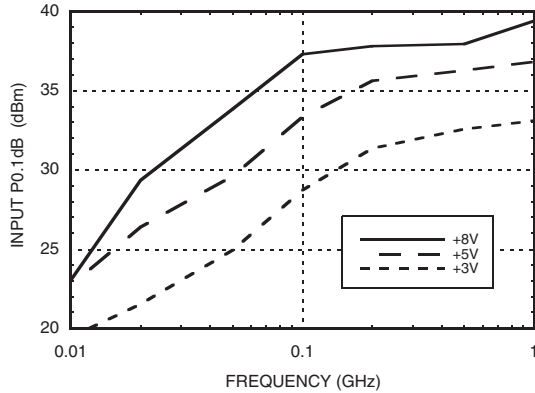

Input P1dB vs. Vctl

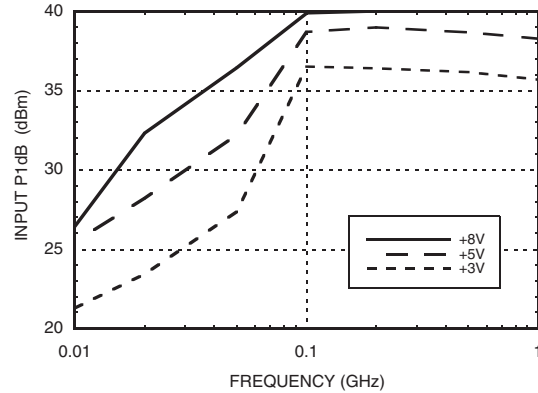

Absolute Maximum Ratings

Max. Input Power $V_{ctl} = 0/+8V$	0.5 - 2.5 GHz	39 dBm
Control Voltage Range (A & B)		-0.2 to +12 Vdc
Hot Switching Power Level $V_{ctl} = 0/+8V$		39 dBm
Channel Temperature		150 °C
Continuous Pdiss ($T = +85\text{ °C}$) (derate 6 mW/°C above 85 °C)		0.38W
Thermal Resistance		173 °C/W
Storage Temperature		-65 to +150 °C
Operating Temperature		-40 to +85 °C
ESD Sensitivity		Class 1A

DC Blocks are required at ports RFC, RF1 and RF2

Control Voltages

State	Bias Condition
Low	0 to +0.2 Vdc @ 10 μ A Typical
High	+3 Vdc @ 2 μ A Typical to +8 Vdc @ 40 μ A Typical (± 0.2 Vdc)

Truth Table

Control Input (Vctl)		Signal Path State	
A	B	RFC to RF1	RFC to RF2
High	Low	Off	On
Low	High	On	Off



**ELECTROSTATIC SENSITIVE DEVICE
OBSERVE HANDLING PRECAUTIONS**

Outline Drawing

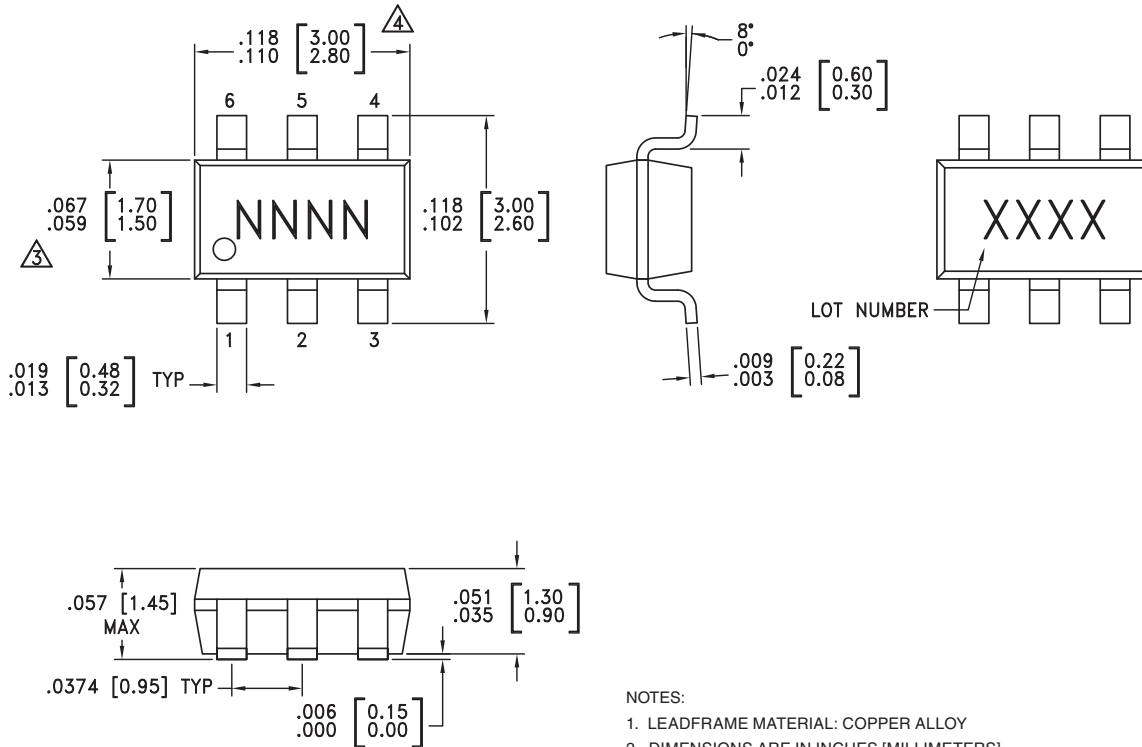

- NOTES:
1. LEADFRAME MATERIAL: COPPER ALLOY
 2. DIMENSIONS ARE IN INCHES [MILLIMETERS]
 - △ DIMENSION DOES NOT INCLUDE MOLDFLASH OF 0.15mm PER SIDE.
 - △ DIMENSION DOES NOT INCLUDE MOLDFLASH OF 0.25mm PER SIDE.
 5. ALL GROUND LEADS MUST BE SOLDERED TO PCB RF GROUND

Package Information

Part Number	Package Body Material	Lead Finish	MSL Rating	Package Marking ^[3]
HMC595	Low Stress Injection Molded Plastic	Sn/Pb Solder	MSL1 ^[1]	H595 XXXX
HMC595E	RoHS-compliant Low Stress Injection Molded Plastic	100% matte Sn	MSL1 ^[2]	595E XXXX

[1] Max peak reflow temperature of 235 °C
 [2] Max peak reflow temperature of 260 °C
 [3] 4-Digit lot number XXXX



Pin Descriptions

Pin Number	Function	Description	Interface Schematic
1, 3, 5	RF2, RF1, RFC	This pin is DC coupled and matched to 50 Ohm. Blocking capacitors are required.	
2	GND	This pin must be connected to RF/DC ground.	
4	B	See truth table and control voltage table.	
6	A	See truth table and control voltage table.	

Typical Application Circuit

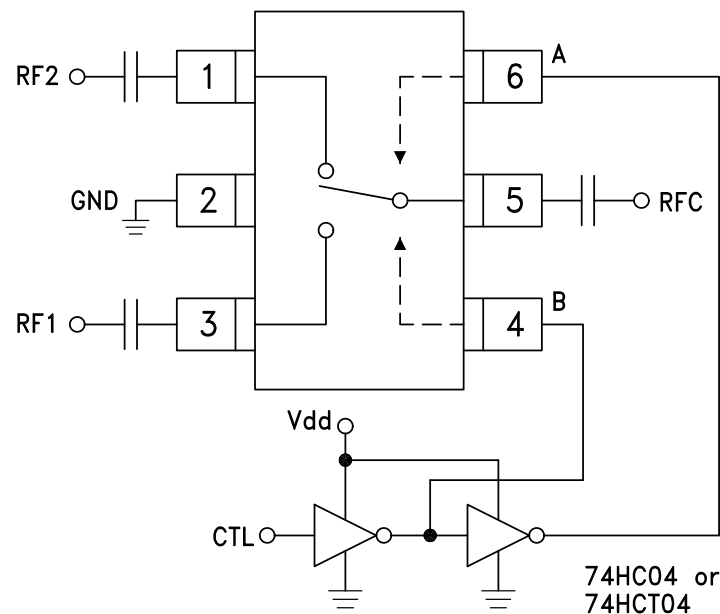

Notes:

1. Set logic gate and switch Vdd = +3V to +5V and use HCT series logic to provide a TTL driver interface.
2. Control inputs A/B can be driven directly with CMOS logic (HC) with Vdd of +3 to +8 Volts applied to the CMOS logic gates.
3. DC Blocking capacitors are required for each RF port as shown. Capacitor value determines lowest frequency of operation.
4. Highest RF signal power capability is achieved with V set to +10V. The switch will operate properly (but at lower RF power capability) at bias voltages down to +3V.

For price, delivery, and to place orders, please contact Hittite Microwave Corporation:
 20 Alpha Road, Chelmsford, MA 01824 Phone: 978-250-3343 Fax: 978-250-3373
 Order On-line at www.hittite.com

Evaluation Circuit Board

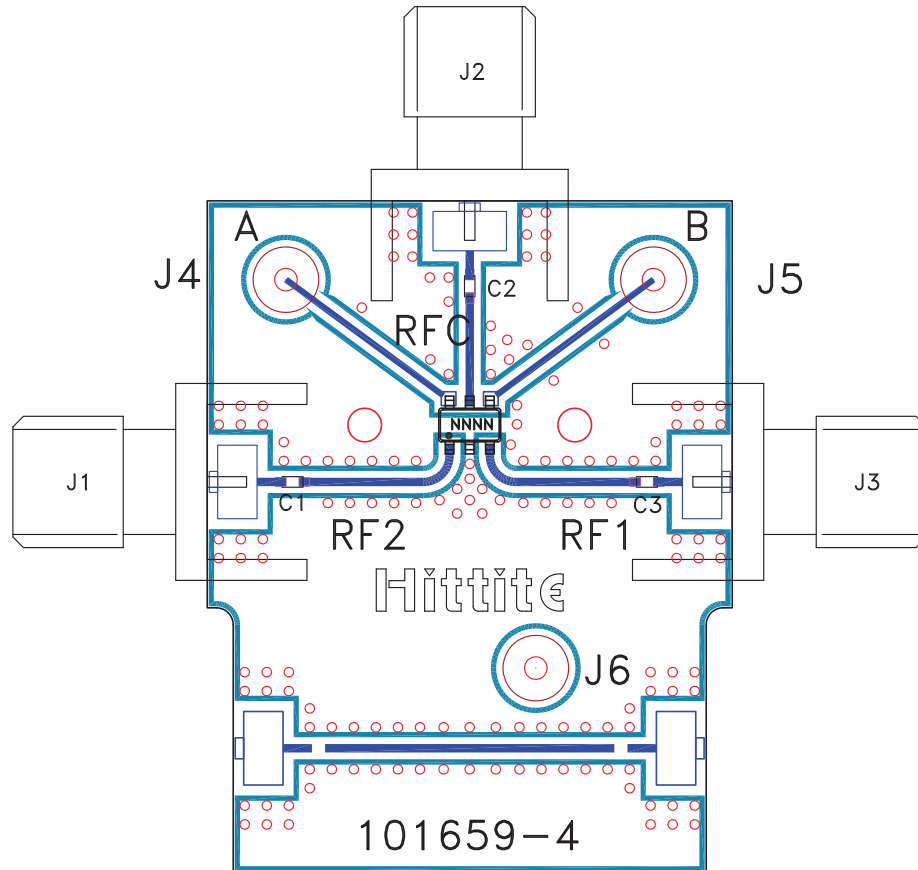

List of Materials for Evaluation PCB 101675 [1]

Item	Description
J1 - J3	PCB Mount SMA RF Connector
J4 - J6	DC Pin
C1 - C3	330 pF capacitor, 0402 Pkg.
U1	HMC595 / HMC595E T/R Switch
PCB [2]	101659 Evaluation PCB

[1] Reference this number when ordering complete evaluation PCB

[2] Circuit Board Material: Rogers 4350

The circuit board used in the final application should be generated with proper RF circuit design techniques. Signal lines at the RF port should have 50 ohm impedance and the package ground leads and package bottom should be connected directly to the ground plane similar to that shown above. The evaluation circuit board shown above is available from Hittite Microwave Corporation upon request.



v00.0805



HMC595 / 595E

**GaAs MMIC 3 WATT T/R SWITCH,
DC - 3 GHz**

Notes:

10

SWITCHES - SMT